

DT0100.0/6A/21.5x11

SPECIFICATION FOR APPROVAL

1、 DIMENSIONS (UNIT:mm) :

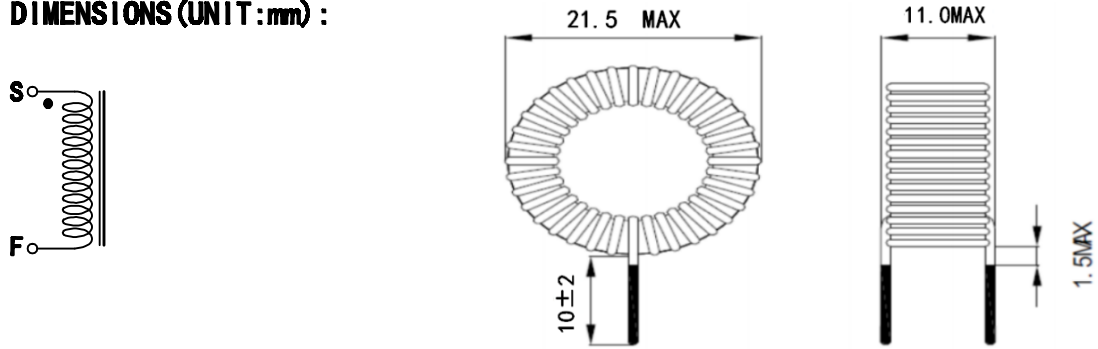

2、 ELECTRICAL CHARACTERISTICS:

L(S-F) : 100.0uH ± 10%	RATED CURRENT: 6A MAX
DCR: 55mΩ MAX	
	MEASURING INSTRUMENT: TH2810B LCR1KHz/1V

3、 MATERIAL LIST:

WIRE: N1 (S-F) : 2UEW φ 0.9mm x 41.0Ts ;
