

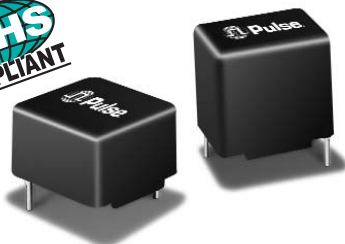



STANDARD LOW POWER INDUCTORS

Switch Mode Power Converters & Ripple Filters



-  Designed for general purpose use
-  High inductance stability with varying volt-seconds and load currents
-  Compact, standard packages
-  Low profile or vertical packages

Electrical Specifications @ 25°C — Operating Temperature -40°C to 130°C

Low Profile ³ Part Number	Vertical ³ Part Number	REFERENCE OPERATING VALUES				DESIGN CONTROL VALUES		
		Inductance Typical (μ H)	I_{DC} ¹ (AMPS)	Maximum ² ET_{OP} (V- μ Sec)	Energy Storage (μ J) ¹	Inductance No DC (μ H \pm 20%)	20kHz Test mV No DC	DCR (Ω MAX)
PE-52625NL	PE-52645NL	150	1.7	80	215	145	110	.42
PE-52626NL	PE-52646NL	220	1.5	90	240	226	140	.42
PE-52627NL	PE-52647NL	330	1.0	100	165	316	170	.78
PE-52628NL	PE-52648NL	470	.90	120	190	480	210	1.26
PE-52629NL	PE-52649NL	680	.85	175	245	690	250	1.50
PE-52630NL	PE-52650NL	820	.75	175	230	780	270	2.40
PE-52631NL	PE-52651NL	1000	.50	175	125	975	300	2.60

NOTES: 1. I_{DC} rated for 40°C Temperature rise @ low ET_{OP} . 2. Derate current 20% at this ET_{OP} .
3. The Leaded version of these parts is available by removing the "NL" suffix when ordering.

Mechanicals

Low Profile Package

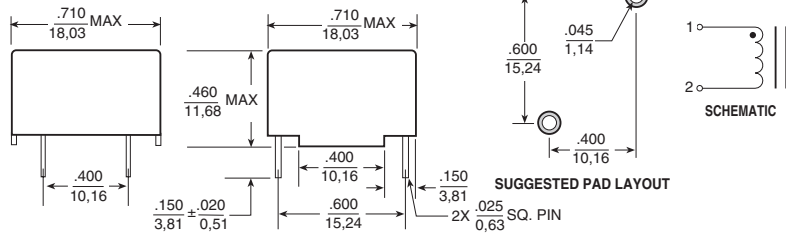

Vertical Package

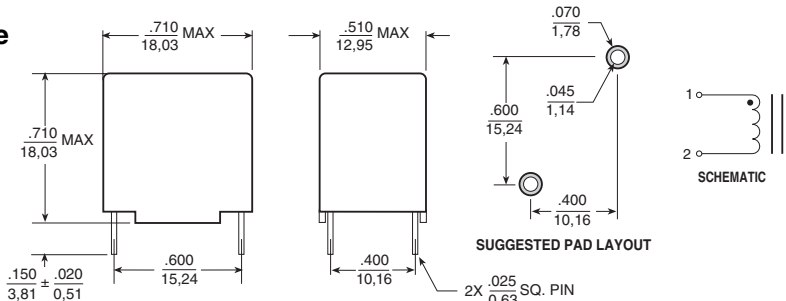

Unless otherwise specified, all tolerances are $\pm .010$
 $0,25$

Dimensions: $\frac{\text{inches}}{\text{mm}}$

Inductance Characteristics

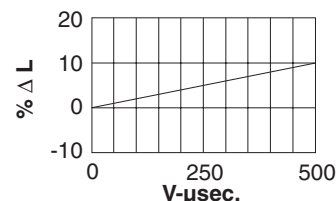

Inductance Variance vs. E.T.

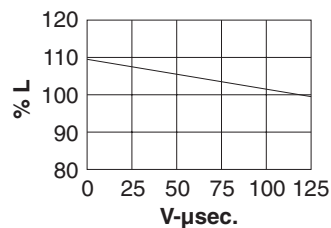

Inductance Variance vs. Load Current

For More Information:

Pulse Worldwide Headquarters

12220 World Trade Drive
San Diego, CA 92128
U.S.A.

www.pulseeng.com
TEL: 858 674 8100
FAX: 858 674 8262

Pulse Northern Europe

3 Huxley Road
Surrey Research Park
Guildford, Surrey GU2 5RE
United Kingdom

TEL: 44 1483 401700
FAX: 44 1483 401701

Pulse Southern Europe

Zone Industrielle
F-39270
Orgelet
France

TEL: 33 3 84 35 04 04
FAX: 33 3 84 25 46 41

Pulse China Headquarters

No. 1
Industrial District
Changan, Dongguan
China

TEL: 86 769 5538070
FAX: 86 769 5538870

Pulse North China

Room 1002
No. 819
Nanjing West Rd
Shanghai
China

TEL: 86 21 32181071
FAX: 86 21 32181396

Pulse South Asia

150 Kampong Ampat
#07-01/02
KA Centre
Singapore 368324

TEL: 65 6287 8998
FAX: 65 6280 0080

Pulse North Asia

3F-4, No. 81, Sec. 1
Hsin Tai Wu Road
Hsi-Chih
Taipei Hsien
Taiwan

TEL: 886 2 26980228
FAX: 886 2 26980948

Performance warranty of products offered on this data sheet is limited to the parameters specified. Data is subject to change without notice. Other brand and product names mentioned herein may be trademarks or registered trademarks of their respective owners.

© Copyright, 2005. Pulse Engineering, Inc. All rights reserved.

Mouser Electronics

Authorized Distributor

Click to View Pricing, Inventory, Delivery & Lifecycle Information:

Pulse:

[PE-52629NL](#) [PE-52631NL](#) [PE-52645NL](#) [PE-52647NL](#) [PE-52648NL](#) [PE-52647](#) [PE-52648](#) [PE-52629](#) [PE-52631](#)
[PE-52627](#) [PE-52626NL](#) [PE-52646](#) [PE-52625](#) [PE-52645](#) [PE-52626](#) [PE-52628](#) [PE-52651](#) [PE-52625NL](#) [PE-](#)
[52651NL](#) [PE-52646NL](#) [PE-52649NL](#)