

SPECIFICATIONS FOR STANDARD LED LAMPS

LSR30243

WENRUN OPTOELECTRONIC

Features:

- High speed response.
- High reliability and long life.
- Low power consumption.
- Available in red,blue,white ,green, yellow colors.
- Suitable for pulse operation.
- This product doesn't contain restriction Substance, comply ROHS standard.

**Descriptions:**

- The LED lamps are available with different colors,intensities,epoxy colors,etc.
- The series specially designed for applications requiring higher brightness.
- Superior performance in outdoor environment.

Applications:

- These lamp are widely used for various application.
- Board for display.
- Indication of all kinds.
- Traffic Signal.

Selection Guide:

| Part No. | Chip | | Lens Type |
|----------|----------|----------------|-------------|
| | Material | Emitting Color | |
| LSR30243 | GaAlAs | Super Red | Water Clear |

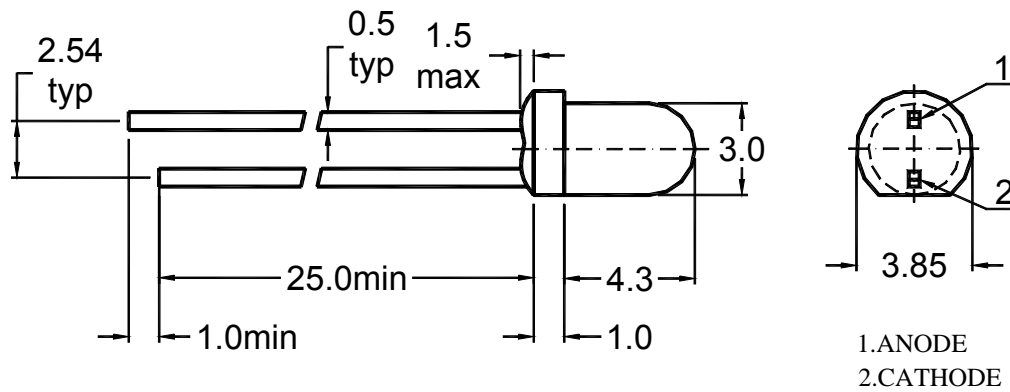
Package Dimensions:**NOTES :**

- 1、 All dimensions are in millimetres (mm).
- 2、 Tolerance is $\pm 0.25\text{mm}(0.01\text{'})$ unless otherwise noted.

Absolute Maximum Rating ($T_a=25$)

| Parameter | Symbol | Super Red | Unit |
|---|-----------|-------------|------|
| Power Dissipation | P_d | 70 | mW |
| Pulse Forward Current (Duty 1/10 @ 1kHz) | I_{FP} | 80 | mA |
| DC Forward Current | I_F | 20 | mA |
| Reverse Voltage | V_R | 5 | V |
| Operating Temperature Range | T_{opr} | -30 ~ +85 | |
| Storage Temperature Range | T_{stg} | -40 ~ +100 | |
| Soldering Temperature | T_{sol} | 260 ± 5 | |

Notes : Soldering time 5 seconds.

Electrical Optical Characteristics (Ta=25)

| Parameter | Symbol | Super Red | | Unit | Test Condition |
|--------------------------|----------------|-----------|------|------|----------------------|
| | | Typ. | Max. | | |
| Luminous Intensity | I _V | 200 | -- | mcd | I _F =20mA |
| Forward Voltage | V _F | 1.8 | 2.3 | V | I _F =20mA |
| Reverse Current | I _R | -- | 50 | uA | V _R =5V |
| Dominant Wavelength | d | 640 | -- | nm | I _F =20mA |
| Peak Emission Wavelength | p | 650 | -- | nm | I _F =20mA |
| Spectral Line Half Width | | 30 | -- | nm | I _F =20mA |
| Viewing Angle | 2 1/2 | 30 | -- | deg | I _F =20mA |

Reliability Test Items and Conditions

| NO | Test Item | Test Conditions | Duration | Sample | Ac/Re |
|----|----------------------|--|-----------|--------|-------|
| 1 | Temperature Cycle | -40 ~ 25 ~ 100 ~ 25 30min 5min 30min 5min | 50cycles | 100 | 0/1 |
| 2 | High Temp. Storage | Ta=100 | 1000hours | 100 | 0/1 |
| 3 | Temp.& Humidity Test | Ta=85 RH=85% | 1000hours | 100 | 0/1 |
| 4 | Low Temp. Storage | Ta=-40 | 1000hours | 100 | 0/1 |
| 5 | Operating Life Test | Ta=25 ± 5 DC IF=20mA | 1000hours | 100 | 0/1 |
| 6 | Solder Heat | Tsol=260 ± 5 , 10s | 1times | 20 | 0/1 |

Typical Electro-Optical Characteristics Curves :

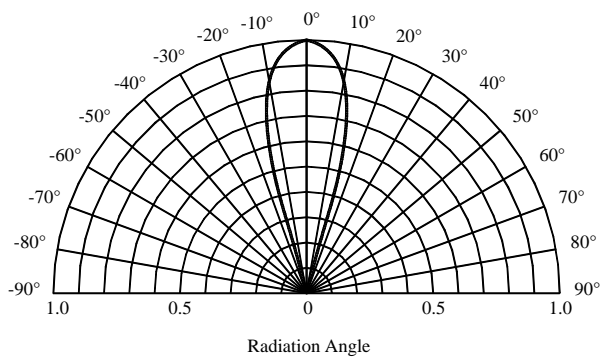
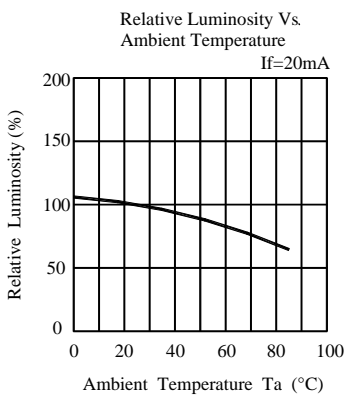
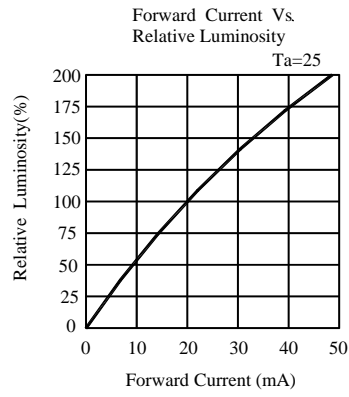
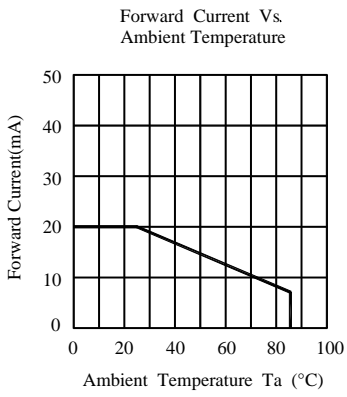
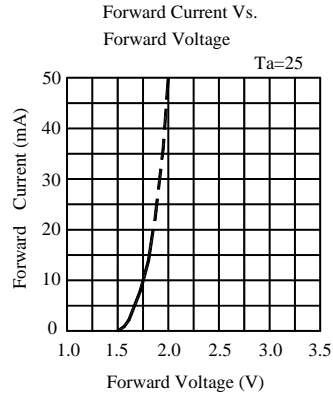
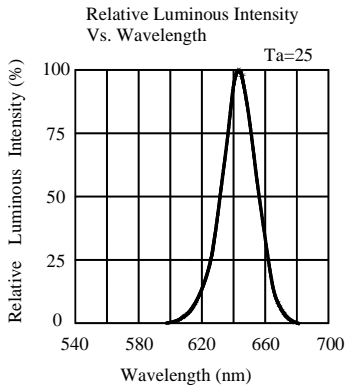

Label Form Specification

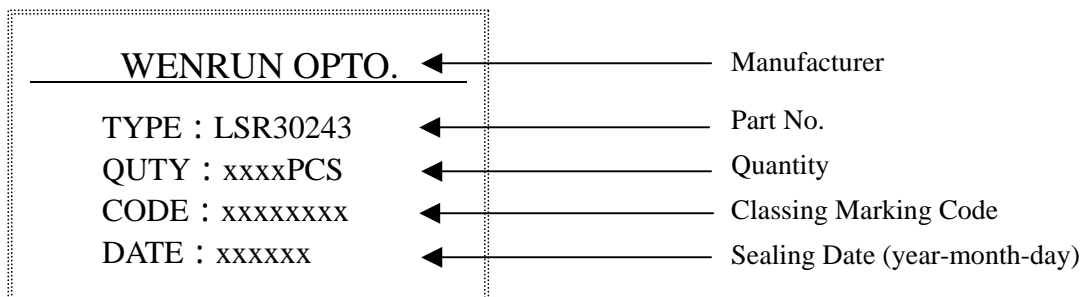

Precautions In Use

A、Soldering Conditions

- 1、When soldering, leave the minimum clearance between the bottom of the resin and the soldering point.
- 2、Maximum allowable soldering conditions are.
Solder dipping: 260 max., 5 seconds max., one time.
Soldering iron: 350 max., 5 seconds max., one time.
- 3、Contact between molten solder and the resin must be avoided.
- 4、In soldering, do not put any stress on the lead frame, particularly when heated.

B、Lead frame Forming and Use

- 1、When forming leads ,the leads should be bent at a point at least 3mm from the base of epoxy. Lead forming should be done before soldering.
- 2、Do not apply any bending stress to the base of the lead. The stress to the base may damage the LEDs characteristics.
- 3、When mounting the LEDs onto a printed circuit board ,the holes on the circuit board should be exactly aligned with the leads of the LEDs.
- 4、Please avoid conditions which may cause the LED to corrode, tarnish or discolor. This corrosion or discoloration may cause difficulty during soldering operations. It is recommended that the LEDs be used as soon as possible.
- 5、Please avoid rapid transitions in ambient temperature, especially, in high humidity environments.

C、Static Electricity

- 1、These products are sensitive to static electricity charge, and users are required to handle with care. Particularly, if an current and or voltage which exceeds the Absolute Maximum Rating of Products is applied, the overflow in energy may cause damage to, or possibly result in electrical destruction of, the Products. The customer is requested to take adequate countermeasures against static electricity charge and surge when handling Products.
- 2、Proper grounding of Products , use of conductive mat, conductive working uniform and shoes, and conductive containers are effective against static electricity and surge.
- 3、Ground low-resistance areas where the product contacts, such as metal surfaces of the work platform, with a conductive mat (surface resistance 10^6 - $10^8 \Omega$).

4、 A tip of soldering iron is requested to be grounded. An ionizer should also be installed where risk of static generation is high.

Notes:

- 1、 Above specification may be changed without notice. We will reserve authority on material change for above specification.
- 2、 When using this product, please observe the absolute maximum ratings and the instructions for the specification sheets. We assume no responsibility for any damage resulting from use of the product which does not comply with the instructions included in the specification sheets.