

■ Features

- High Luminous LEDs
- 3mm Round Standard Directivity
- Superior Weather-resistance
- UV Resistant Epoxy

■ Applications

- Electronic Signs And Signals
- Small Area Illuminations
- Back Lighting/ Indication Lighting

■ Outline Dimension

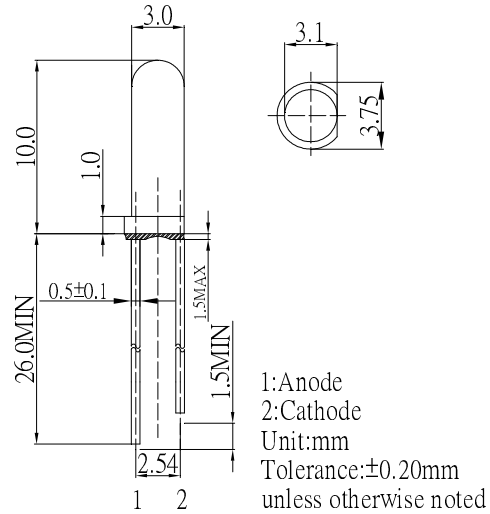

■ Absolute Maximum Rating

(Ta=25°C)

Item	Symbol	Value		Unit
		W/M/K/BL/PG	Y/O/R	
DC Forward Current	I _F	30	30	mA
Pulse Forward Current*	I _{FP}	100	100	mA
Reverse Voltage	V _R	5	5	V
Power Dissipation	P _D	102	78	mW
Operating Temperature	T _{opr}	-30 ~ +85		°C
Storage Temperature	T _{stg}	-40 ~ +100		°C
Lead Soldering Temperature	T _{sol}	260 °C/5sec		-

*Pulse width Max.10ms Duty ratio max 1/10

■ Directivity

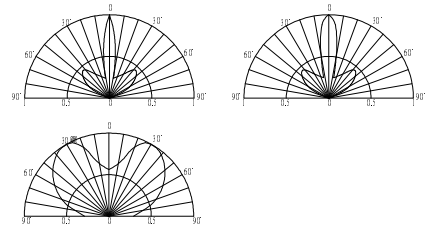

■ Electrical -Optical Characteristics

(Ta=25°C)











Part Number	Color		V _F (V)			I _R (μA)	I _v (mcd)			CCT(K)*			201/2(deg)
			Min.	Typ.	Max.	Max.	Min.	Typ.	Max.	Min.	Typ.	Max.	Typ.
			I _F =20mA			V _R =5V		I _F =20mA					
OSW5DK6C21A	Cool White	W	2.7	2.9	3.4	10	4200	5800	-	8500-18000K(X:0.27,Y:0.28)			20
OSM5DK6C21A	Warm White	M	2.7	2.9	3.4	10	4200	5800	-	2700-3300K(X:0.44,Y:0.41)			20
OSK5DK6C21A	Pink	K	2.7	2.9	3.4	10	1120	1560	-	X:0.45,Y:0.17			20
OSW5DK6CF2A	Cool White	W	2.7	2.9	3.4	10	750	1120	-	8500-18000K(X:0.27,Y:0.28)			150
OSM5DK6CF2A	Warm White	M	2.7	2.9	3.4	10	750	1120	-	2700-3300K(X:0.44,Y:0.41)			150
OSK5DK6CF2A	Pink	K	2.7	2.9	3.4	10	220	330	-	X:0.45,Y:0.17			150

*1 Tolerance of measurements of chromaticity coordinate is ±10%

*2 Tolerance of measurements of luminous intensity is ±15%

*3 Tolerance of measurements of forward voltage is ±0.1V

■ **Electrical -Optical Characteristics** (Ta=25°C)

Part Number	Color			V _F (V)			I _R (μA)	I _v (mcd)			Wd(nm)*			2θ1/2(deg)
				Min.	Typ.	Max.	Max.	Min.	Typ.	Max.	Min.	Typ.	Max.	Typ.
				I _F =20mA			V _R =5V	I _F =20mA						
OSB5SA6C21A	Blue	BL		2.7	3.0	3.4	10	1560	2180	-	465	470	475	20
OSG5DA6C21A	Pure Green	PG		2.7	3.0	3.4	10	5800	7000	-	520	525	530	20
OSY5RU6C11A	Yellow	Y		1.8	2.1	2.6	10	750	900	-	585	590	595	15
OSO5JA6C11A	Orange	O		1.8	2.1	2.6	10	500	750	-	600	605	610	15
OSR5RU6C11A	Red	R		1.8	2.1	2.6	10	750	900	-	620	625	630	15
OSB5SA6CF2A	Blue	BL		2.7	3.0	3.4	10	150	220	-	465	470	475	150
OSG5DA6CF2A	Pure Green	PG		2.7	3.0	3.4	10	500	750	-	520	525	530	150
OSY5RU6CF2A	Yellow	Y		1.8	2.1	2.6	10	100	150	-	585	590	595	150
OSO5JA6CF2A	Orange	O		1.8	2.1	2.6	10	68	100	-	600	605	610	150
OSR5RU6CF2A	Red	R		1.8	2.1	2.6	10	100	150	-	620	625	630	150

*1 Tolerance of measurements of dominant wavelength is ±1nm

*2 Tolerance of measurements of luminous intensity is ±15%

*3 Tolerance of measurements of forward voltage is ±0.1V