

PMU 8000 Series PoL Regulators
 Input 4.5-17 V, Output up to 8 A / 44 W

1/28701 - BMR668 Rev. D September 2020

© Flex

Key Features

- Small size
7.5 x 7.5 x 5.4 mm (0.3 x 0.3 x 0.21 in)
- 0.6 V – 5.5V output voltage range
- 8A maximum output current
- High efficiency, typ. 92.7% at 12 Vin, 3.3 Vout, 6A load
- Adjustable fixed switching frequency (200 kHz to 1.6 MHz)
- Control loop with fast load transient response
- Allows synchronization to an external clock
- Meets safety requirements according to IEC/EN/UL 62368-1
- MTBF 171.82 Mh

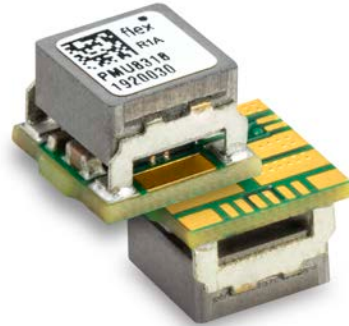

General Characteristics

- Output short-circuit protection
- Over temperature protection
- Remote control
- Output voltage adjust function
- Soft start (SS) or Tracking is configurable
- Power Good
- Highly automated manufacturing ensures quality
- ISO 9001/14001 certified supplier

Safety Approvals



Design for Environment



Meets requirements in high-temperature lead-free soldering processes.

Contents

Ordering Information	2
General Information	2
Safety Specification	3
Pin-out Descriptions	4
Absolute Maximum Ratings	5
Electrical Specification	
4 A / 0.6-5.5 V	PMU8218..... 6
6 A / 0.6-5.5 V	PMU8318..... 11
8 A / 0.6-5.5 V	PMU8418..... 16
Operating Information	21
Thermal Consideration	29
Mechanical Information	31
Soldering Information	32
Delivery Package Information	33
Product Qualification Specification	34

PMU 8000 Series PoL Regulators
Input 4.5-17 V, Output up to 8 A / 44 W

1/28701 - BMR668 Rev. D September 2020

© Flex

Ordering Information

Product number	Output
PMU8218	0.6-5.5V, 4A/22W
PMU8318	0.6-5.5V, 6A/33W
PMU8418	0.6-5.5V, 8A/44W

Product number and Packaging

PMU8X18 n ₁	
Options	n ₁
Delivery package information	o

Options	Description
n ₁	C Tape and reel (600 pcs /reel) D Tape and reel (150 pcs /reel)

Example: PMU8318 C means a surface mounted, positive logic product with tape and reel packaging, the reel capacity is 600 pcs products per reel.

General Information

Reliability

The failure rate (λ) and mean time between failures (MTBF = $1/\lambda$) is calculated at max output power and an operating ambient temperature (T_A) of +40°C. Flex Power uses Telcordia SR-332 Issue 4 to calculate the mean steady-state failure rate and standard deviation (σ).

Telcordia SR-332 Issue 4 also provides techniques to estimate the upper confidence levels of failure rates based on the mean and standard deviation.

Mean steady-state failure rate, λ	Std. deviation, σ
6 nFailures/h	3.4 nFailures/h

MTBF (mean value) for the PMU series = 171.82 Mh.

MTBF at 90% confidence level = 97.88 Mh

Compatibility with RoHS requirements

The products are compatible with the relevant clauses and requirements of the RoHS directive 2011/65/EU and 2015/863 and have a maximum concentration value of 0.1% by weight in homogeneous materials for lead, mercury, hexavalent chromium, PBB, PBDE, DEHP, BBP, DBP, DIBP and of 0.01% by weight in homogeneous materials for cadmium.

Exemptions in the RoHS directive utilized in Flex Power products are found in the Statement of Compliance document.

Flex Power fulfills and will continuously fulfill all its obligations under regulation (EC) No 1907/2006 concerning the registration, evaluation, authorization and restriction of

chemicals (REACH) as they enter into force and is through product materials declarations preparing for the obligations to communicate information on substances in the products.

Quality Statement

The products are designed and manufactured in an industrial environment where quality systems and methods like ISO 9000, Six Sigma, and SPC are intensively in use to boost the continuous improvements strategy. Infant mortality or early failures in the products are screened out and they are subjected to an ATE-based final test. Conservative design rules, design reviews and product qualifications, plus the high competence of an engaged work force, contribute to the high quality of the products.

Warranty

Warranty period and conditions are defined in Flex General Terms and Conditions of Sale.

Limitation of Liability

Flex does not make any other warranties, expressed or implied including any warranty of merchantability or fitness for a particular purpose (including, but not limited to, use in life support applications, where malfunctions of product can cause injury to a person's health or life).

© Flex 2020

The information and specifications in this technical specification is believed to be correct at the time of publication. However, no liability is accepted for inaccuracies, printing errors or for any consequences thereof. Flex reserves the right to change the contents of this technical specification at any time without prior notice.

PMU 8000 Series PoL Regulators Input 4.5-17 V, Output up to 8 A / 44 W	1/28701 - BMR668 Rev. D September 2020 © Flex
--	--

Safety Specification

General information

Flex DC/DC converters and DC/DC regulators are designed in accordance with the safety standards IEC 62368-1, EN 62368-1 and UL 62368-1 *Audio/video, information and communication technology equipment - Part 1: Safety requirements*

IEC/EN/UL 62368-1 contains requirements to prevent injury or damage due to the following hazards:

- Electrical shock
- Electrically-caused fire
- Injury caused by hazardous substances
- Mechanically-caused injury
- Skin burn
- Radiation-caused injury

On-board DC/DC converters, Power interface modules and DC/DC regulators are defined as component power supplies. As components they cannot fully comply with the provisions of any safety requirements without “conditions of acceptability”. Clearance between conductors and between conductive parts of the component power supply and conductors on the board in the final product must meet the applicable safety requirements. Certain conditions of acceptability apply for component power supplies with limited stand-off (see Mechanical Information for further information). It is the responsibility of the installer to ensure that the final product housing these components complies with the requirements of all applicable safety standards and regulations for the final product.

Component power supplies for general use shall comply with the requirements in IEC/EN/UL 62368-1. Product related standards, e.g. IEEE 802.3af *Power over Ethernet*, and ETS-300132-2 *Power interface at the input to telecom equipment, operated by direct current (dc)* are based on IEC/EN/UL 60950-1 with regards to safety.

Flex DC/DC converters, Power interface modules and DC/DC regulators are UL 62368-1 recognized and certified in accordance with EN 62368-1. The flammability rating for all construction parts of the products meet requirements for V-0 class material according to IEC 60695-11-10, *Fire hazard testing, test flames – 50 W horizontal and vertical flame test methods*.

Non - isolated DC/DC regulators

The DC/DC regulator output is ES1 energy source if the input source meets the requirements for ES1 according to IEC/EN/UL 62368-1.

PMU 8000 Series PoL Regulators
Input 4.5-17 V, Output up to 8 A / 44 W

1/28701 - BMR668 Rev. D September 2020

© Flex

Pin configuration and functions

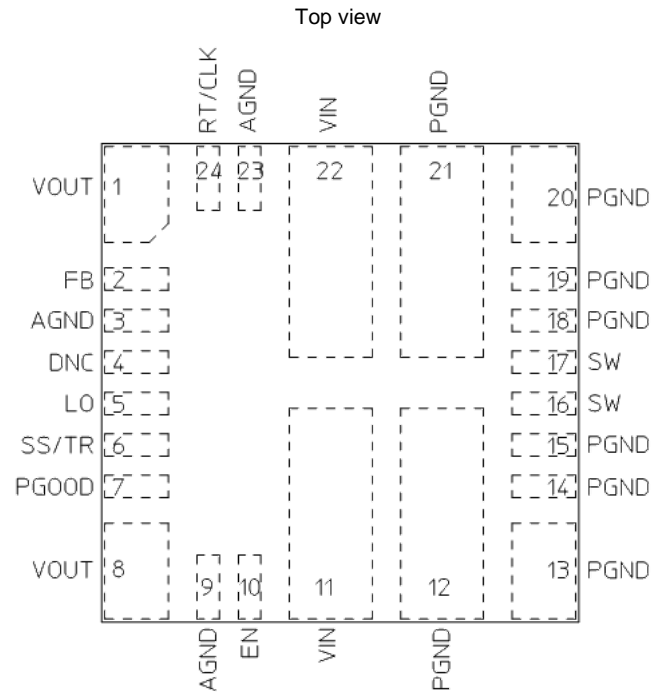

Pin Functions

Pin	Designation	Type	Function
3, 9, 23	AGND	G	Analog ground, reference for logic signals. Connect these pins together using a plane but do not connect these pins to PGND. These pins are connected internally.
4	DNC		Do Not Connect.
10	EN	I	Enable. Leave open or pull high to enable the device. Connect a voltage divider to implement adjustable undervoltage lockout and hysteresis. See section Undervoltage Lockout (UVLO) .
2	FB	I	Regulator feedback input. Connect the output voltage feedback resistor divider to this pin. See section Output Voltage Adjust (FB) .
12, 13, 14, 15, 18, 19, 20, 21	PGND	G	Power ground. This is the common ground connection for VIN and VOUT power connections.
7	PGOOD	O	Power-Good indicator. This open drain output asserts low if the output voltage is outside of the PGOOD thresholds, VIN is lower than its UVLO threshold, EN is low, device is in thermal shutdown or device is in soft-start. Use a 10-k Ω to 100-k Ω pullup resistor to logic rail or other DC voltage no higher than 6.5 V.
24	RT/CLK	I	Switching frequency setting pin. In RT mode, an external timing resistor adjusts the switching frequency. In CLK mode, the device synchronizes to an external clock input to this pin. See sections Switching Frequency (RT) and Synchronization (CLK) .
6	SS/TR	I	Soft-start and tracking pin. Connecting an external capacitor to this pin adjusts the output voltage soft start ramp slower than its 1.25-ms default setting. This pin can also be used for tracking and sequencing. See section Soft Start (SS) and Output Voltage Sequencing and Tracking (TR) .
16, 17	SW	O	Switch node. Leave these pins open.
5	LO	I	Loop Optimization pin. Internal loop compensation network. Connect the required Loop Optimization resistor between this pin and AGND. Do not leave this pin floating. See section Loop Optimization (LO) .
11, 22	VIN	I	Input voltage. Connect both pins to the input power source with a low impedance connection.
1, 8	VOUT	O	Output voltage. These pins are connected to the internal output inductor. Connect these pins to the output load.

PMU 8000 Series PoL Regulators
 Input 4.5-17 V, Output up to 8 A / 44 W

1/28701 - BMR668 Rev. D September 2020
 © Flex

Typical Application Circuit

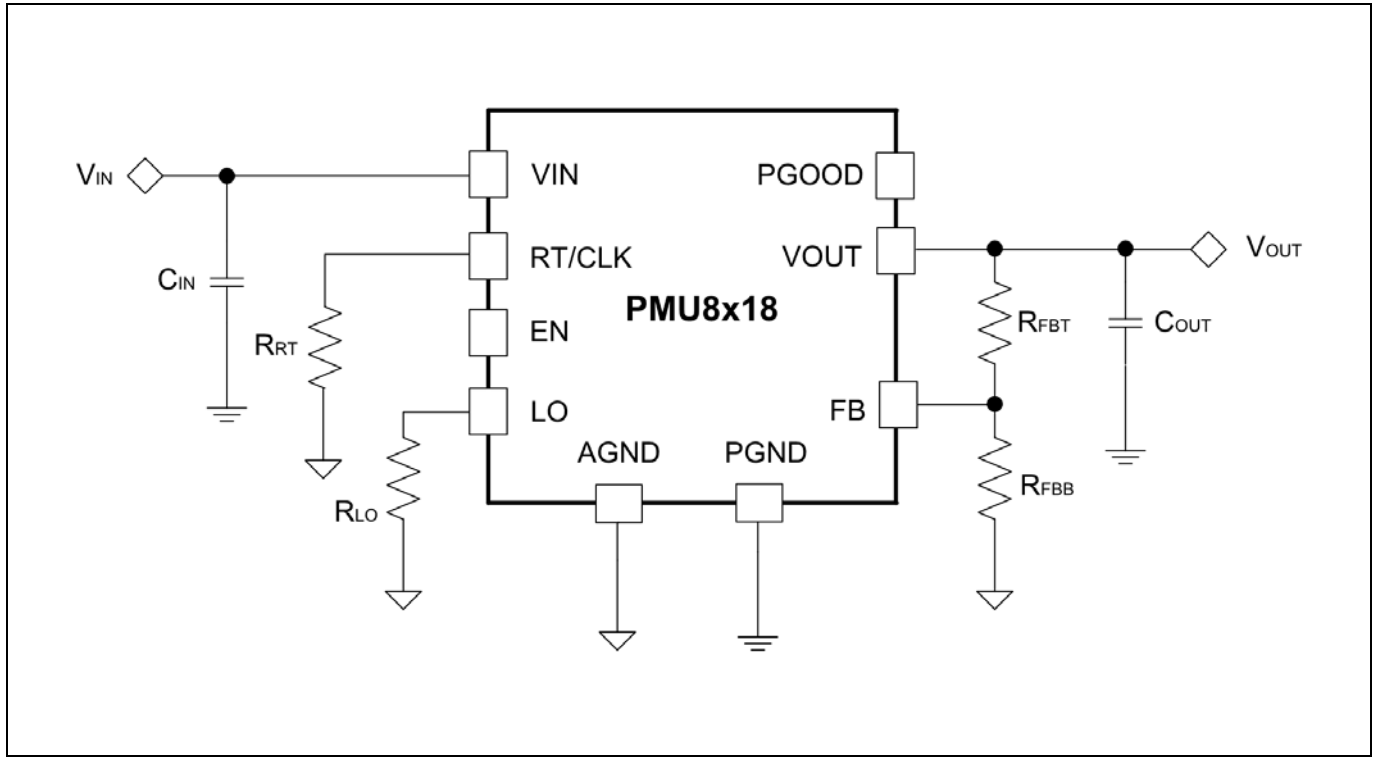

Absolute Maximum Ratings

Characteristics		min	max	Unit
T _{ref}	Operating Temperature	-40	125	°C
T _s	Storage temperature	-40	150	°C
Input Voltage	V _{IN}	-0.3	19	V
	EN, PGOOD, SS/TRK, RT/CLK, FB	-0.3	6.5	V
	AGND to PGND	-0.3	0.3	V
Output voltage	SW	-1	V _{IN} +1	V
	SW (<10ns transients)	-3	V _{IN} +3	V
	V _{OUT}	-0.3	V _{IN}	V

Stress in excess of Absolute Maximum Ratings may cause permanent damage. Absolute Maximum Ratings, sometimes referred to as no destruction limits, are normally tested with one parameter at a time exceeding the limits in the Electrical Specification. If exposed to stress above these limits, function and performance may degrade in an unspecified manner.

Recommended Operating Conditions

Characteristics		min	typ	max	Unit
Input voltage, Note 1		4.5	12	17	V
Output voltage		0.6		5.5	V
EN voltage	Rising threshold		1.2	1.26	V
	Falling threshold	1.1	1.15		
PGOOD pullup voltage				5.5	V
PGOOD sink current				1	mA
RT/CLK voltage range		0		5.5	V
Output current	PMU8218	0		4	A
	PMU8318	0		6	
	PMU8418	0		8	
Operating temperature, T _{P1}		-40		105	°C

Note 1. For output voltages from 0.6V to 5 V, the recommended minimum V_{IN} is 4.5 V or (V_{OUT} + 1 V), whichever is greater. For output voltages 5.0 V to 5.5 V, the recommended minimum V_{IN} is (V_{OUT} + 2 V).

PMU 8000 Series PoL Regulators
 Input 4.5-17 V, Output up to 8 A / 44 W

1/28701 - BMR668 Rev. D September 2020

© Flex

1.0V, 4A / 4W Electrical Specification**PMU8218**
 $T_{P1} = -40$ to $+105$ °C, $V_I = 4.5$ to 17 V, unless otherwise specified under Conditions.

 Typical values given at: $T_{P1} = +25$ °C, $V_I = 12$ V, max I_O , unless otherwise specified under Conditions.

 Additional $C_{IN} = 100$ μ F Electrolytic + 2×10 μ F Ceramic capacitors and $C_{OUT} = 4 \times 47$ μ F Ceramic capacitors.

Characteristics		Conditions	min	typ	max	Unit
V_I	Input voltage range		4.5	12	17	V
V_{loff}	Turn-off input voltage	Decreasing input voltage	3.7	3.9		V
V_{lon}	Turn-on input voltage	Increasing input voltage		4.1	4.3	V
C_I	Internal input capacitance			2		μ F
P_O	Output power		0		4.0	W
η	Efficiency	$V_I = 12$ V, 50 % of max I_O		87.6		%
		$V_I = 12$ V, max I_O		88.5		
P_d	Power Dissipation	$V_I = 12$ V, 50 % of max I_O		0.28		W
		$V_I = 12$ V, max I_O		0.52		W
P_{ii}	Input idling power	$V_I = 12$ V		0.17		W
P_{RC}	Input standby power	$V_I = 12$ V		20		mW
f_s	Switching frequency	10-100 % of max I_O		350		kHz
V_{oi}	Output voltage initial setting and accuracy	$V_I = 12$ V, max I_O		1.0		V
V_O	Output voltage tolerance band	10-100 % of max I_O		± 1.5		%
	Idling voltage	$V_I = 12$ V, $I_O = \text{min } I_O$		1.0		V
	Line regulation	$I_O = \text{max } I_O$		± 0.1		mV
	Load regulation	$V_I = 12$ V, 0-100 % of max I_O		± 0.9		mV
V_{tr}	Load transient voltage deviation	$V_I = 12$ V, Load step 25-75-25 % of max I_O , $di/dt = 2$ A/ μ s With Loop Optimization		± 29		mV
t_{tr}	Load transient recovery time	$C_{OUT} = 518$ μ F; $R_{LO} = 3$ k Ω		37		μ s
t_r	Ramp-up time (from 10–90 % of V_O)	$V_I = 12$ V, 100 % of max I_O		1.1		ms
t_s	Start-up time (from V_I connection to 90 % of V_O)			1.6		ms
t_f	V_I shut-down fall time. (from V_I off to 10 % of V_O)	$V_I = 12$ V	$I_O = \text{max } I_O$		12.8	ms
			$I_O = \text{min } I_O$		1.0	s
$t_{RC} t_{inh}$	RC start-up time	$V_I = 12$ V, max I_O		1.5		ms
	RC shut-down fall time (from RC off to 10 % of V_O)	$V_I = 12$ V	$I_O = \text{max } I_O$		120	μ s
			$I_O = \text{min } I_O$		1.2	s
I_O	Output current		0		4	A
I_{lim}	Current limit threshold			11.7		A
I_{sc}	Short circuit current	RMS, 12 m Ω short		2.3		A
C_{in}	External input capacitance	Ceramic type	20			μ F
		Non-ceramic type, Note 2		100		
C_{out}	External output capacitance	Note 3	188		1500	μ F
V_{Oac}	Output ripple & noise $V_I = 12$ V	$I_O = \text{max } I_O$		8.5		mVp-p

Note 2. For Non-ceramic type of external input capacitor, a 100 μ F bulk capacitor is recommended for application with transient load requirement. An OS-CON capacitor is recommended when adding the bulk capacitor in low temperature.

Note 3. A minimum external output ceramic capacitance is required. In low output voltage, more capacitance might to be added considering capacitance derating. The maximum external output capacitor could only be ceramic type or combination of ceramic and a single non-ceramic type.

PMU 8000 Series PoL Regulators
 Input 4.5-17 V, Output up to 8 A / 44 W

1/28701 - BMR668 Rev. D September 2020
 © Flex

1.0V, 4A / 4W Typical Characteristics

PMU 8218

Efficiency

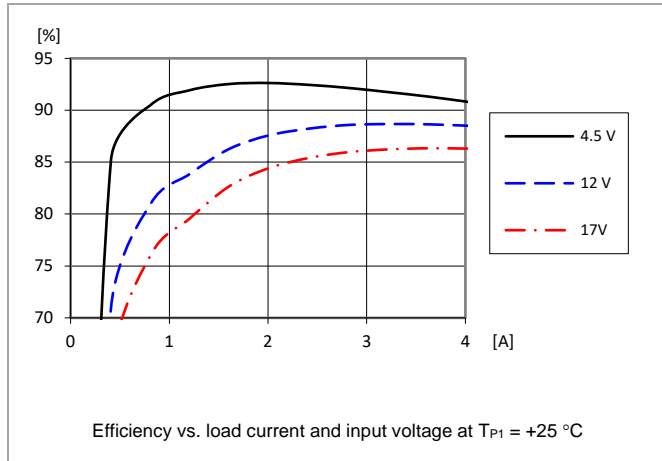

Power Dissipation

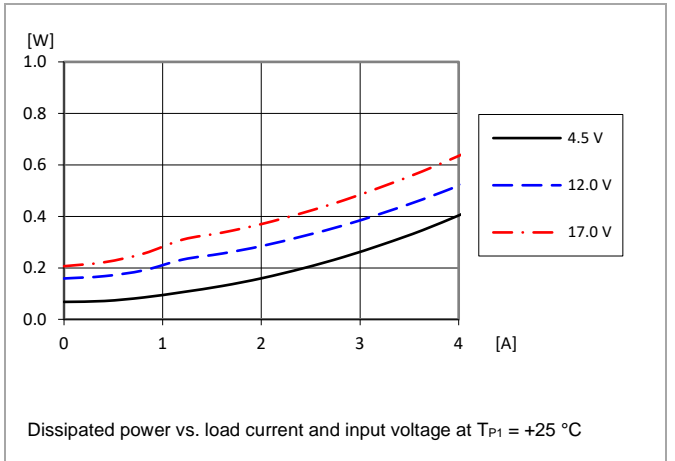

Output Ripple & Noise

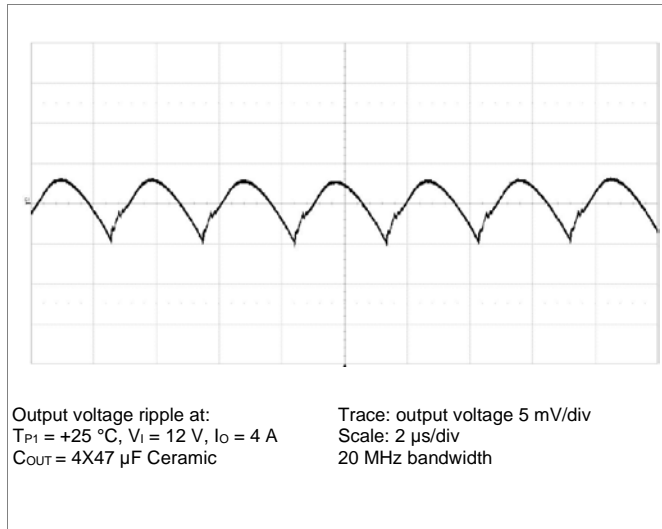

Transient Response

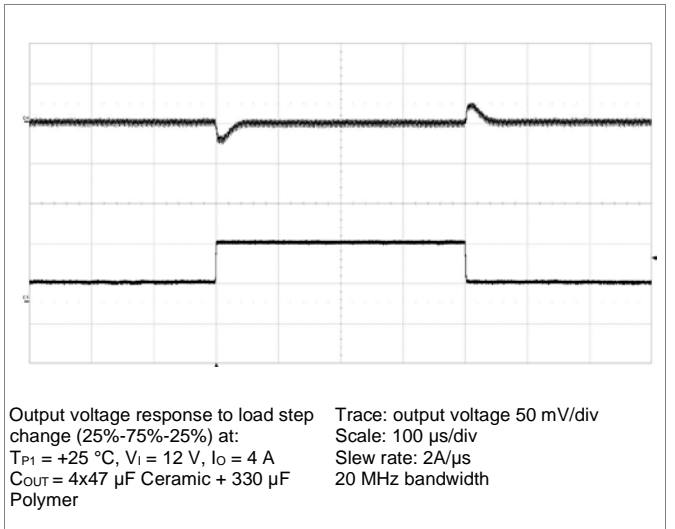

Start up by EN pin

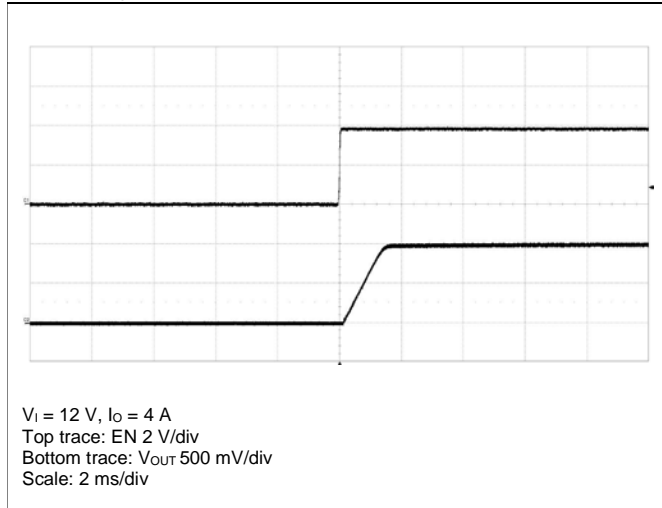

Shut down by EN pin

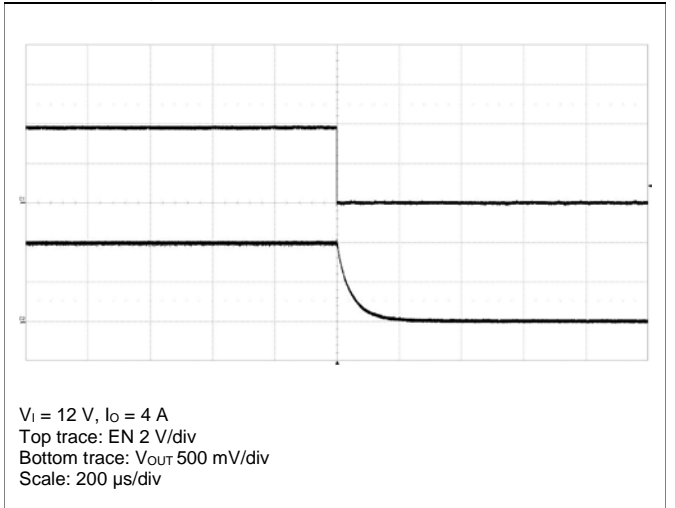

PMU 8000 Series PoL Regulators
 Input 4.5-17 V, Output up to 8 A / 44 W

1/28701 - BMR668 Rev. D September 2020

© Flex

3.3V, 4A / 13.2W Electrical Specification**PMU8218**
 $T_{P1} = -40$ to $+105$ °C, $V_I = 4.5$ to 17 V, unless otherwise specified under Conditions.

 Typical values given at: $T_{P1} = +25$ °C, $V_I = 12$ V, max I_O , unless otherwise specified under Conditions.

 Additional $C_{IN} = 100$ μ F Electrolytic + 2×10 μ F Ceramic capacitors and $C_{OUT} = 4 \times 47$ μ F Ceramic capacitors.

Characteristics		Conditions	min	typ	max	Unit
V_I	Input voltage range		4.5	12	17	V
V_{loff}	Turn-off input voltage	Decreasing input voltage	3.7	3.9		V
V_{lon}	Turn-on input voltage	Increasing input voltage		4.1	4.3	V
C_i	Internal input capacitance			2		μ F
P_O	Output power		0		13.2	W
η	Efficiency	$V_I = 12$ V, 50 % of max I_O		91.4		%
		$V_I = 12$ V, max I_O		93.1		
P_d	Power Dissipation	$V_I = 12$ V, 50 % of max I_O		0.62		W
		$V_I = 12$ V, max I_O		1.0		W
P_{ii}	Input idling power	$V_I = 12$ V		0.4		W
P_{RC}	Input standby power	$V_I = 12$ V		20		mW
f_s	Switching frequency	0-100 % of max I_O		1.0		MHz
V_{oi}	Output voltage initial setting and accuracy	$V_I = 12$ V, max I_O		3.31		V
V_O	Output voltage tolerance band	10-100 % of max I_O		± 1.5		%
	Idling voltage	$V_I = 12$ V, $I_O = \text{min } I_O$		3.31		V
	Line regulation	$I_O = \text{max } I_O$		± 0.4		mV
	Load regulation	$V_I = 12$ V, 0-100 % of max I_O		± 1.6		mV
V_{tr}	Load transient voltage deviation	$V_I = 12$ V, Load step 25-75-25 % of max I_O , $di/dt = 2$ A/ μ s		± 40		mV
t_{tr}	Load transient recovery time	With Loop Optimization $C_{OUT} = 518$ μ F; $R_{LO} = 11$ k		80		μ s
t_r	Ramp-up time (from 10-90 % of V_O)	$V_I = 12$ V, 100 % of max I_O		1.1		ms
t_s	Start-up time (from V_I connection to 90 % of V_O)			1.7		ms
t_f	V_I shut-down fall time. (from V_I off to 10 % of V_O)	$V_I = 12$ V	$I_O = \text{max } I_O$		8.2	ms
			$I_O = \text{min } I_O$		0.13	s
t_{RC} t_{inh}	RC start-up time		$V_I = 12$ V, max I_O		1.4	ms
	RC shut-down fall time (from RC off to 10 % of V_O)	$V_I = 12$ V	$I_O = \text{max } I_O$		0.36	ms
			$I_O = \text{min } I_O$		1.3	s
I_O	Output current		0		4	A
I_{lim}	Current limit threshold			11.7		A
I_{sc}	Short circuit current	RMS, 12 m Ω short		2.35		A
C_{in}	External input capacitance	Ceramic type		20		μ F
		Non-ceramic type, Note 2		100		
C_{out}	External output capacitance	Note 3		47	1500	μ F
V_{Oac}	Output ripple & noise $V_I = 12$ V	$I_O = \text{max } I_O$		3.9		mVp-p

Note 2. For Non-ceramic type of external input capacitor, a 100 μ F bulk capacitor is recommended for application with transient load requirement. An OS-CON capacitor is recommended when adding the bulk capacitor in low temperature.

Note 3. A minimum external output ceramic capacitance is required. In low output voltage, more capacitance might to be added considering capacitance derating. The maximum external output capacitor could only be ceramic type or combination of ceramic and a single non-ceramic type.

PMU 8000 Series PoL Regulators
 Input 4.5-17 V, Output up to 8 A / 44 W

1/28701 - BMR668 Rev. D September 2020
 © Flex

3.3V, 4A / 13.2W Typical Characteristics

PMU 8218

Efficiency

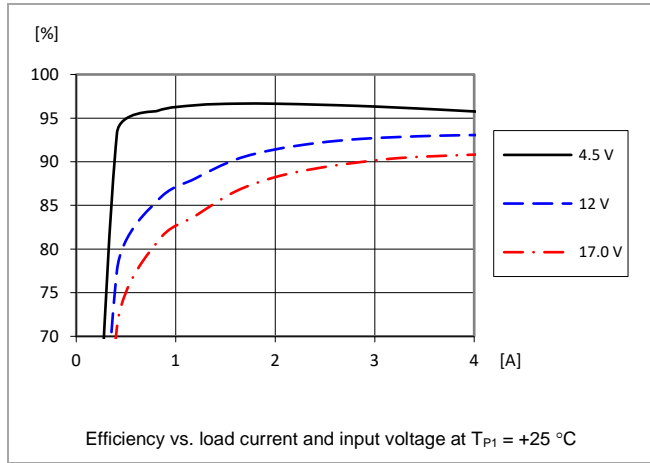

Power Dissipation

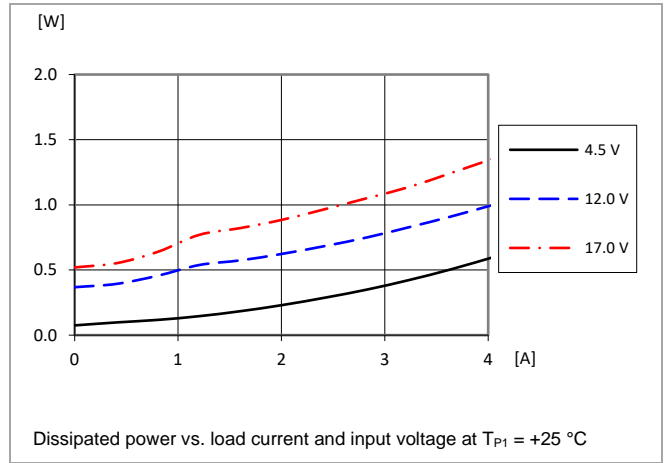

Output Ripple & Noise

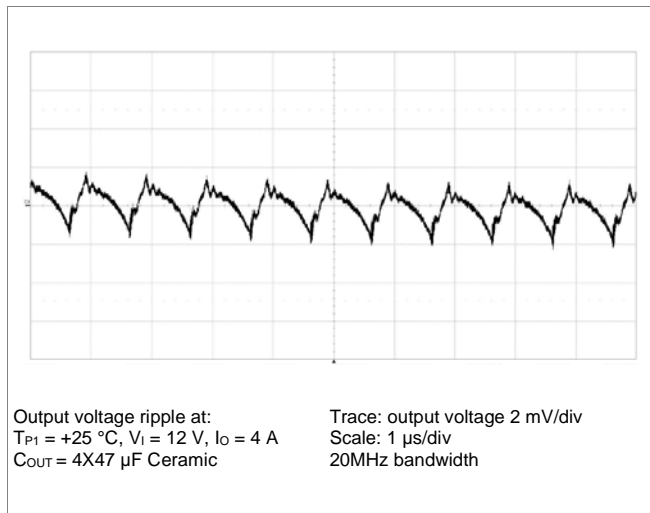

Transient Response

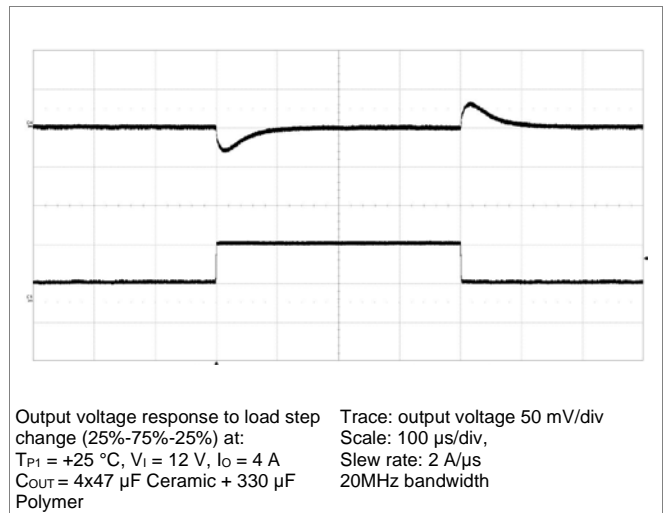

Start up by EN pin

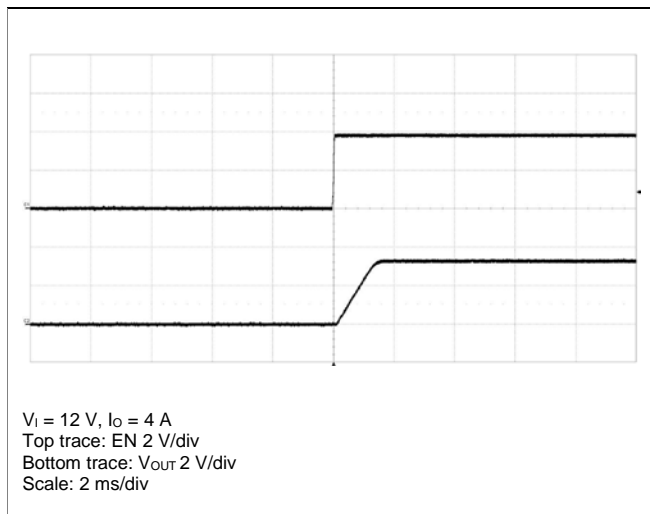

Shut down by EN pin

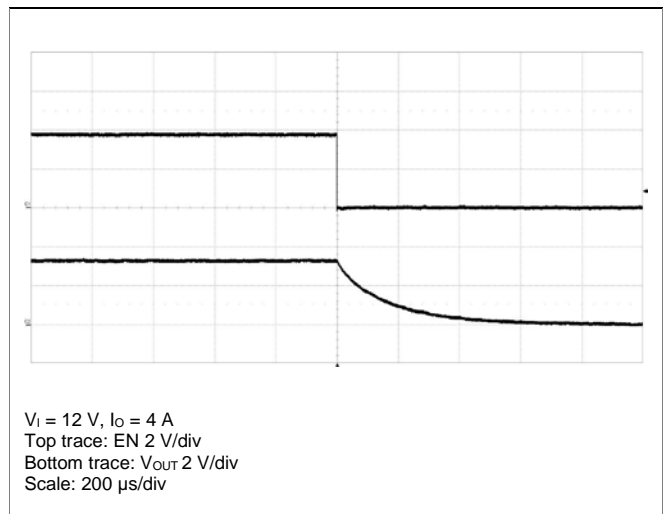

PMU 8000 Series PoL Regulators
 Input 4.5-17 V, Output up to 8 A / 44 W

1/28701 - BMR668 Rev. D September 2020
 © Flex

Typical Characteristics ($V_{IN} = 12V$)

PMU 8218

Efficiency

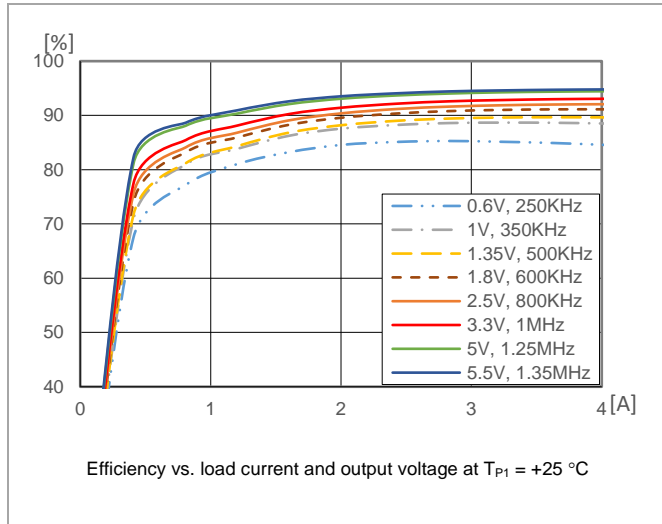

Power Dissipation

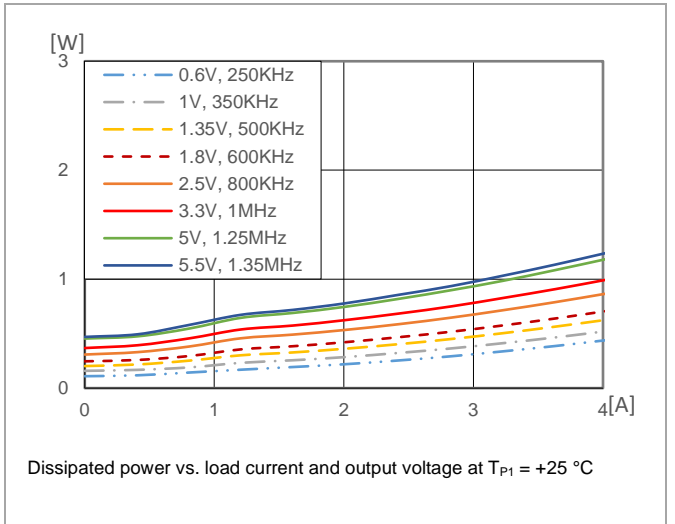

Output voltage ripple

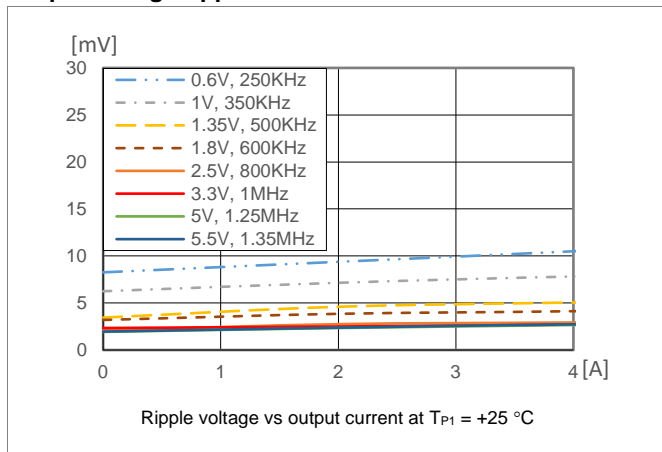

Output current derating

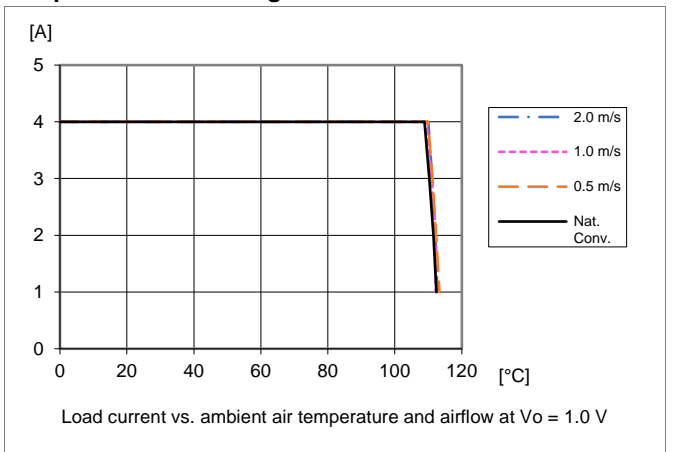

Output current derating

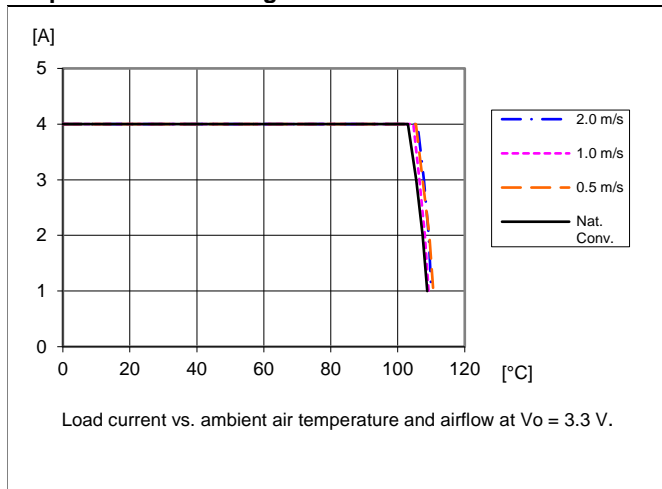

Output current derating

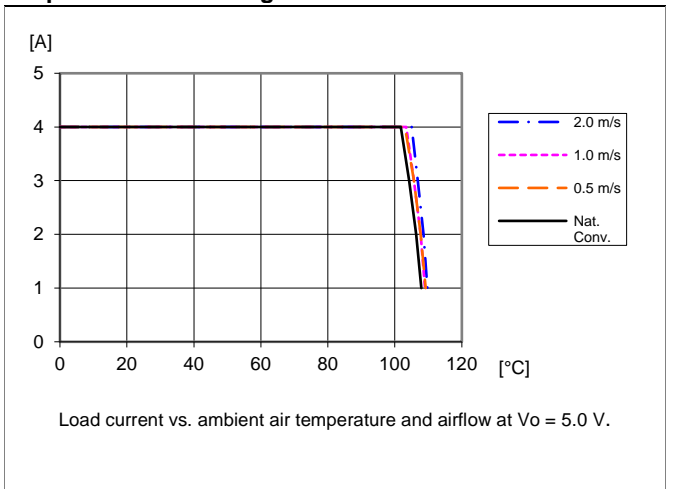

PMU 8000 Series PoL Regulators
Input 4.5-17 V, Output up to 8 A / 44 W

1/28701 - BMR668 Rev. D September 2020
© Flex

1.0V, 6A / 6W Electrical Specification

PMU8318

$T_{P1} = -40$ to $+105$ °C, $V_I = 4.5$ to 17 V, unless otherwise specified under Conditions.
Typical values given at: $T_{P1} = +25$ °C, $V_I = 12$ V, max I_O , unless otherwise specified under Conditions.
Additional $C_{IN} = 100$ µF Electrolytic + 2×10 µF Ceramic capacitors and $C_{OUT} = 4 \times 47$ µF Ceramic capacitors.

Characteristics		Conditions	min	typ	max	Unit
V_I	Input voltage range		4.5	12	17	V
V_{loff}	Turn-off input voltage	Decreasing input voltage	3.7	3.9		V
V_{lon}	Turn-on input voltage	Increasing input voltage		4.1	4.3	V
C_I	Internal input capacitance			2		µF
P_O	Output power		0		6.0	W
η	Efficiency	$V_I = 12$ V, 50 % of max I_O		88.6		%
		$V_I = 12$ V, max I_O		87.0		
P_d	Power Dissipation	$V_I = 12$ V, 50 % of max I_O		0.40		W
		$V_I = 12$ V, max I_O		0.90		W
P_{ii}	Input idling power	$V_I = 12$ V		0.17		W
P_{RC}	Input standby power	$V_I = 12$ V		20		mW
f_s	Switching frequency	10-100 % of max I_O		350		kHz
V_{oi}	Output voltage initial setting and accuracy	$V_I = 12$ V, max I_O		1.0		V
V_O	Output voltage tolerance band	10-100 % of max I_O		±1.5		%
	Idling voltage	$V_I = 12$ V, $I_O = \text{min } I_O$		1.0		V
	Line regulation	$I_O = \text{max } I_O$		±0.14		mV
	Load regulation	$V_I = 12$ V, 0-100 % of max I_O		±1.6		mV
V_{tr}	Load transient voltage deviation	$V_I = 12$ V, Load step 25-75-25 % of max I_O , $di/dt = 2$ A/µs With Loop Optimization		±39		mV
t_{tr}	Load transient recovery time	$C_{OUT} = 518$ µF; $R_{LO} = 3$ kΩ		40		µs
t_r	Ramp-up time (from 10-90 % of V_O)	$V_I = 12$ V, 100 % of max I_O		1.1		ms
t_s	Start-up time (from V_I connection to 90 % of V_O)			1.6		ms
t_f	V_I shut-down fall time. (from V_I off to 10 % of V_O)	$V_I = 12$ V	$I_O = \text{max } I_O$		9.8	ms
			$I_O = \text{min } I_O$		1.0	s
$t_{RC} t_{inh}$	RC start-up time	$V_I = 12$ V	$I_O = \text{max } I_O$		1.5	ms
	RC shut-down fall time (from RC off to 10 % of V_O)		$I_O = \text{max } I_O$		75.3	µs
			$I_O = \text{min } I_O$		1.2	s
I_O	Output current		0		6	A
I_{lim}	Current limit threshold			11.7		A
I_{sc}	Short circuit current	RMS, 12 mΩ short		2.3		A
C_{in}	External input capacitance	Ceramic type		20		µF
		Non-ceramic type, Note 2		100		
C_{out}	External output capacitance	Note 3	188		1500	µF
V_{Oac}	Output ripple & noise $V_I = 12$ V	$I_O = \text{max } I_O$		8.25		mVp-p

Note 2. For Non-ceramic type of external input capacitor, a 100 µF bulk capacitor is recommended for application with transient load requirement. An OS-CON capacitor is recommended when adding the bulk capacitor in low temperature.
Note 3. A minimum external output ceramic capacitance is required. In low output voltage, more capacitance might to be added considering capacitance derating. The maximum external output capacitor could only be ceramic type or combination of ceramic and a single non-ceramic type.

PMU 8000 Series PoL Regulators
 Input 4.5-17 V, Output up to 8 A / 44 W

1/28701 - BMR668 Rev. D September 2020
 © Flex

1.0V,6A / 6W Typical Characteristics

PMU 8318

Efficiency

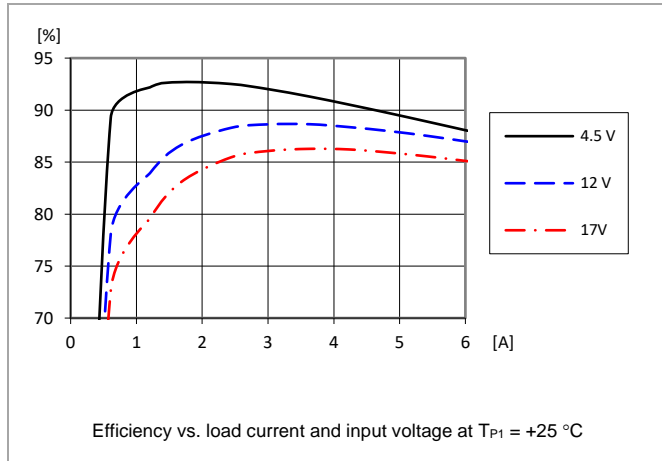

Power Dissipation

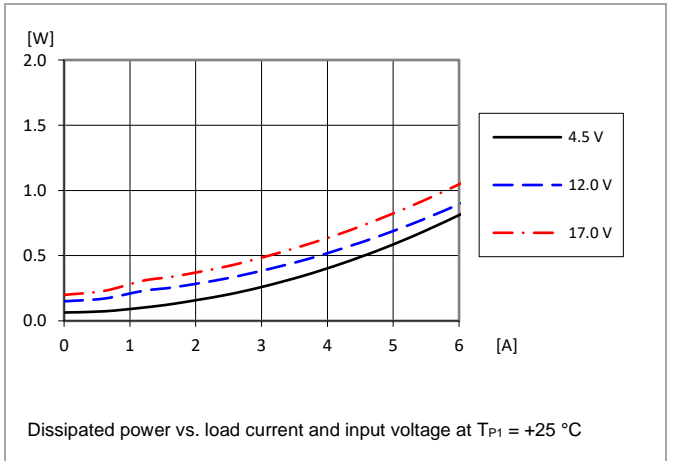

Output Ripple & Noise

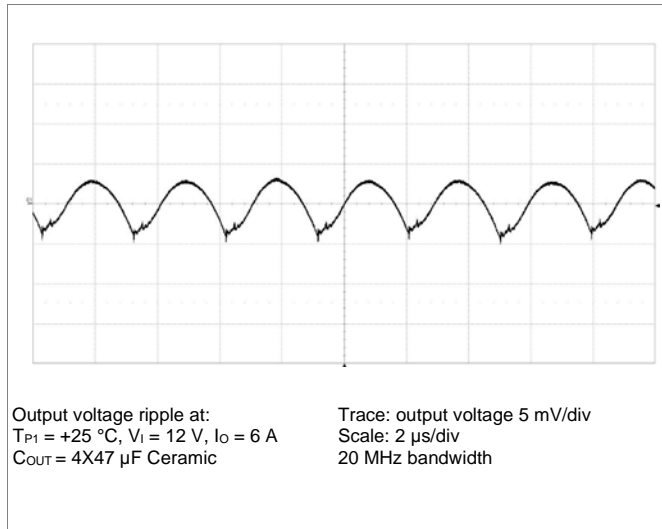

Transient Response

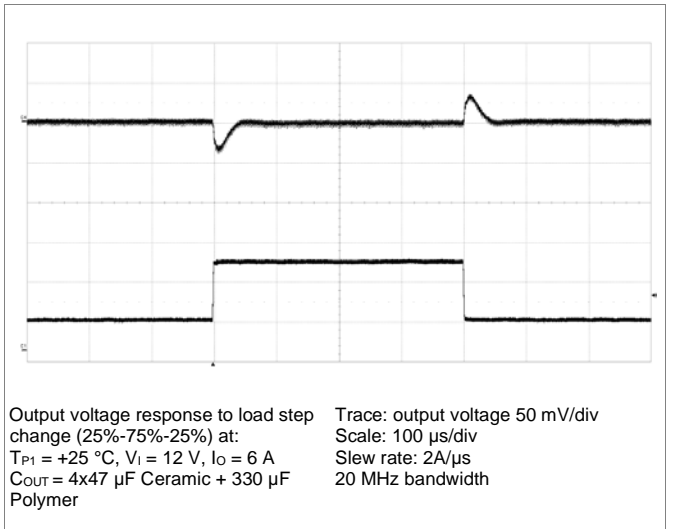

Start up by EN pin

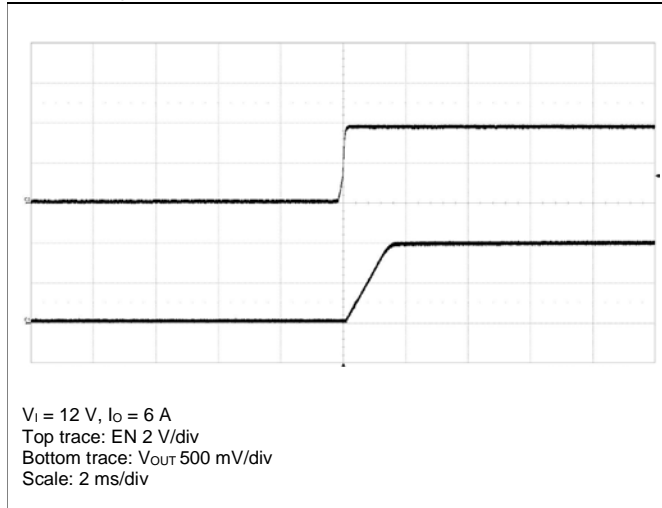

Shut down by EN pin

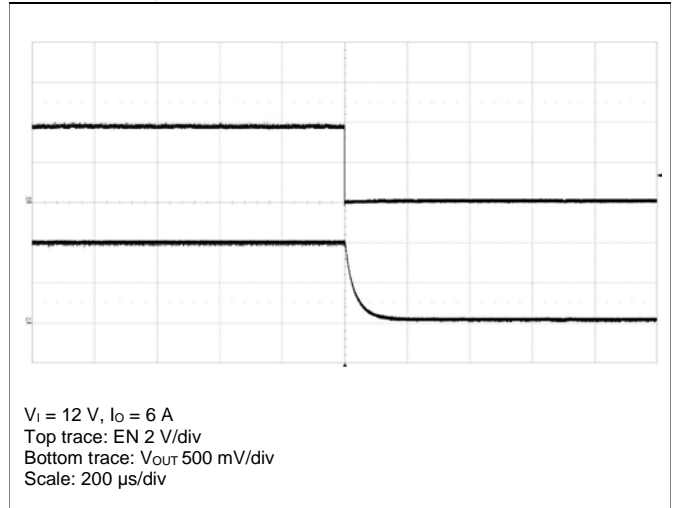

PMU 8000 Series PoL Regulators
 Input 4.5-17 V, Output up to 8 A / 44 W

 1/28701 - BMR668 Rev. D September 2020
 © Flex

3.3V, 6A / 19.8W Electrical Specification
PMU8318
 $T_{P1} = -40$ to $+105$ °C, $V_I = 4.5$ to 17 V, unless otherwise specified under Conditions.

 Typical values given at: $T_{P1} = +25$ °C, $V_I = 12$ V, max I_O , unless otherwise specified under Conditions.

 Additional $C_{IN} = 100$ μ F Electrolytic + 2×10 μ F Ceramic capacitors and $C_{OUT} = 4 \times 47$ μ F Ceramic capacitors.

Characteristics		Conditions	min	typ	max	Unit
V_I	Input voltage range		4.5	12	17	V
V_{loff}	Turn-off input voltage	Decreasing input voltage	3.7	3.9		V
V_{lon}	Turn-on input voltage	Increasing input voltage		4.1	4.3	V
C_I	Internal input capacitance			2		μ F
P_O	Output power		0		19.8	W
η	Efficiency	$V_I = 12$ V, 50 % of max I_O		92.7		%
		$V_I = 12$ V, max I_O		92.7		
P_d	Power Dissipation	$V_I = 12$ V, 50 % of max I_O		0.80		W
		$V_I = 12$ V, max I_O		1.56		W
P_{ii}	Input idling power	$V_I = 12$ V		0.4		W
P_{RC}	Input standby power	$V_I = 12$ V		20		mW
f_s	Switching frequency	0-100 % of max I_O		1.0		MHz
V_{Oi}	Output voltage initial setting and accuracy	$V_I = 12$ V, max I_O		3.31		V
V_O	Output voltage tolerance band	10-100 % of max I_O		± 1.5		%
	Idling voltage	$V_I = 12$ V, $I_O = \text{min } I_O$		3.31		V
	Line regulation	$I_O = \text{max } I_O$		± 0.58		mV
	Load regulation	$V_I = 12$ V, 0-100 % of max I_O		± 1.26		mV
V_{tr}	Load transient voltage deviation	$V_I = 12$ V, Load step 25-75-25 % of max I_O , $di/dt = 2$ A/ μ s With Loop Optimization		± 50		mV
t_{tr}	Load transient recovery time	$C_{OUT} = 518$ μ F; $R_{LO} = 11$ k		100		μ s
t_r	Ramp-up time (from 10-90 % of V_O)	$V_I = 12$ V, 100 % of max I_O		1.1		ms
t_s	Start-up time (from V_I connection to 90 % of V_O)			1.7		ms
t_f	V_I shut-down fall time. (from V_I off to 10 % of V_O)	$V_I = 12$ V	$I_O = \text{max } I_O$		7.4	ms
			$I_O = \text{min } I_O$		0.13	s
$t_{RC} t_{inh}$	RC start-up time	$V_I = 12$ V, max I_O		1.4		ms
	RC shut-down fall time (from RC off to 10 % of V_O)	$V_I = 12$ V	$I_O = \text{max } I_O$		0.36	ms
			$I_O = \text{min } I_O$		1.3	s
I_O	Output current		0		6	A
I_{lim}	Current limit threshold			11.7		A
I_{sc}	Short circuit current	RMS, 12 m Ω short		2.35		A
C_{in}	External input capacitance	Ceramic type		20		μ F
		Non-ceramic type, Note 2		100		
C_{out}	External output capacitance	Note 3	47		1500	μ F
V_{Oac}	Output ripple & noise $V_I = 12$ V	$I_O = \text{max } I_O$		2.96		mVp-p

Note 2. For Non-ceramic type of external input capacitor, a 100 μ F bulk capacitor is recommended for application with transient load requirement. An OS-CON capacitor is recommended when adding the bulk capacitor in low temperature.

Note 3. A minimum external output ceramic capacitance is required. In low output voltage, more capacitance might to be added considering capacitance derating. The maximum external output capacitor could only be ceramic type or combination of ceramic and a single non-ceramic type.

PMU 8000 Series PoL Regulators
 Input 4.5-17 V, Output up to 8 A / 44 W

1/28701 - BMR668 Rev. D September 2020
 © Flex

3.3V, 6A / 19.8W Typical Characteristics

PMU 8318

Efficiency

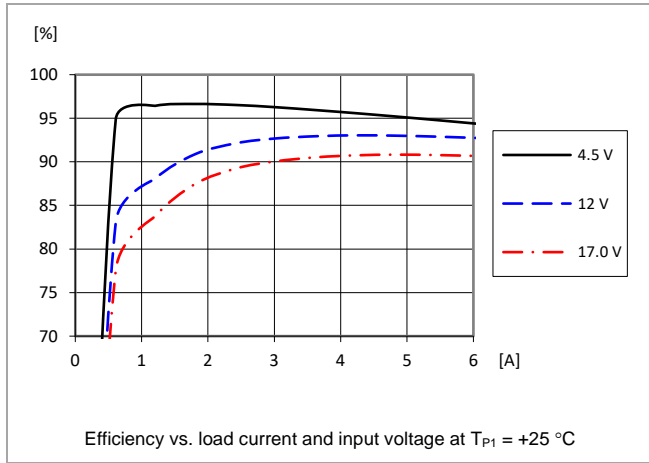

Power Dissipation

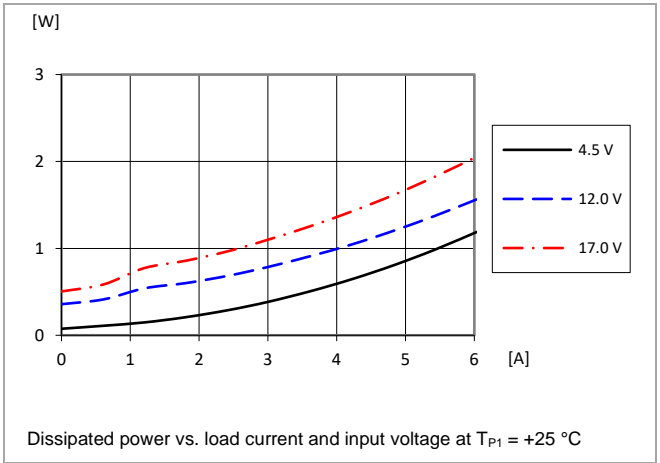

Output Ripple & Noise

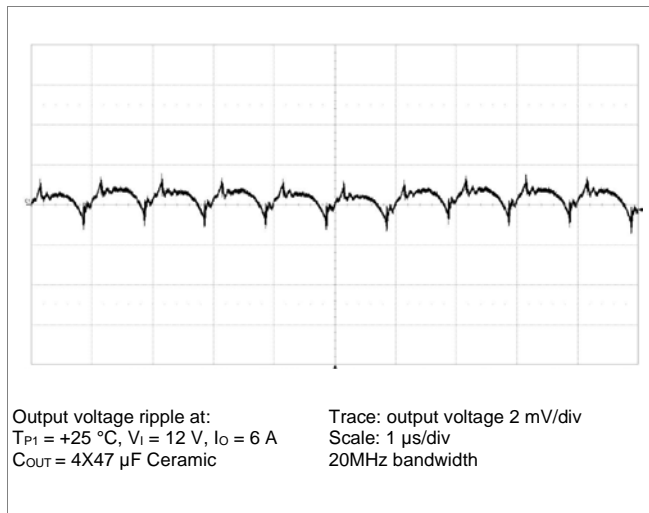

Transient Response

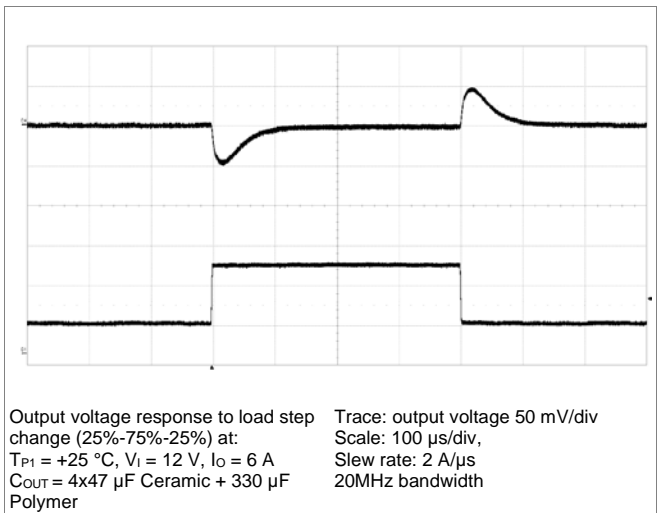

Start up by EN pin

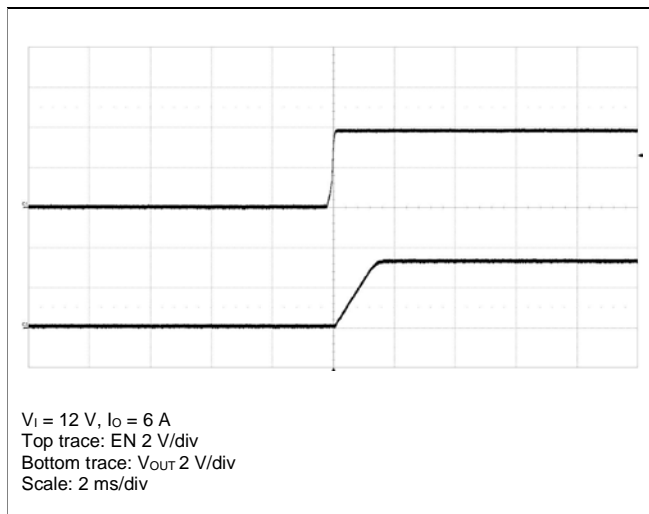

Shut down by EN pin

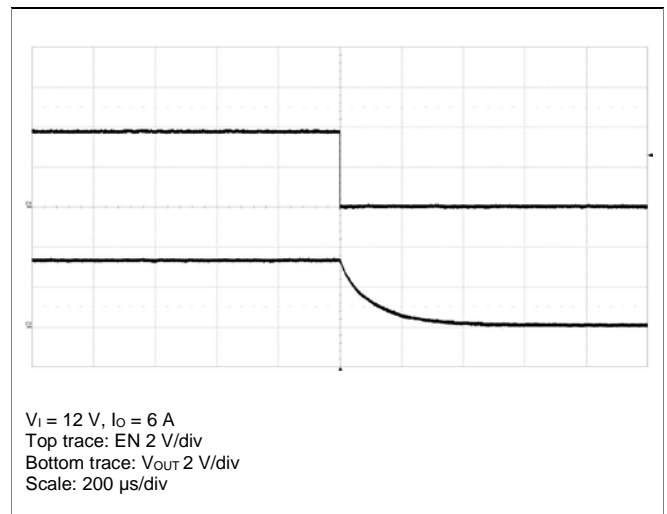

PMU 8000 Series PoL Regulators
 Input 4.5-17 V, Output up to 8 A / 44 W

1/28701 - BMR668 Rev. D September 2020
 © Flex

Typical Characteristics ($V_{IN} = 12V$)

PMU 8318

Efficiency

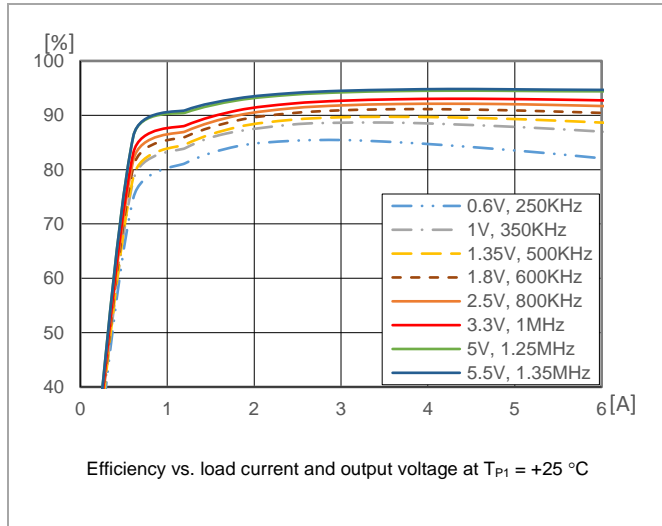

Power Dissipation

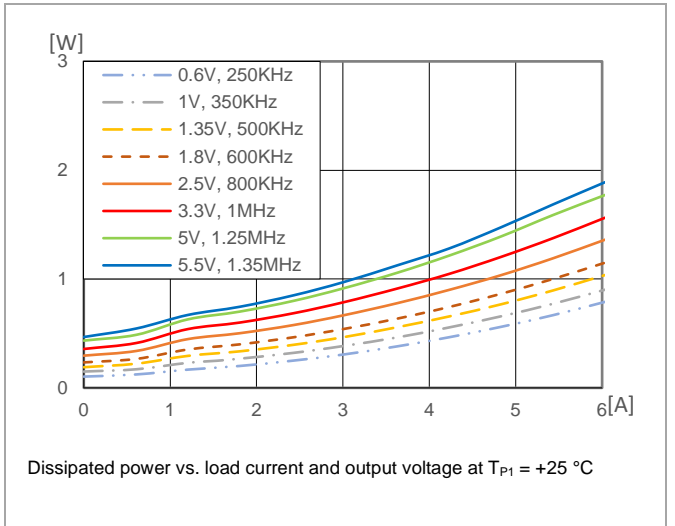

Output voltage ripple

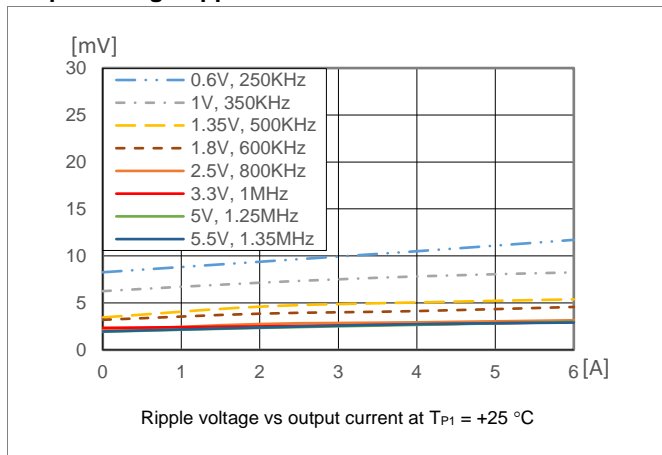

Output current derating

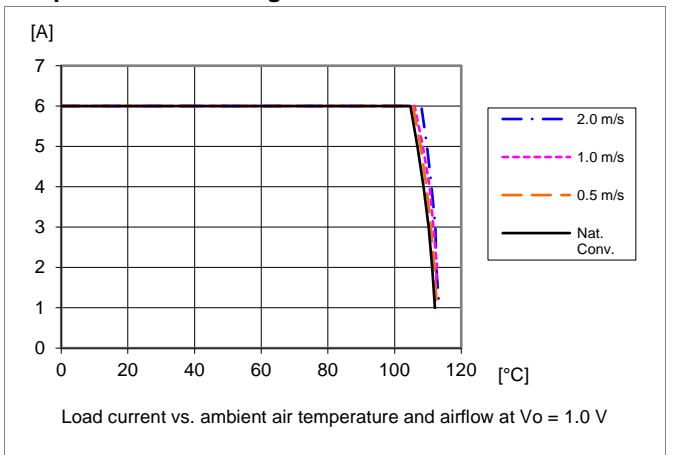

Output current derating

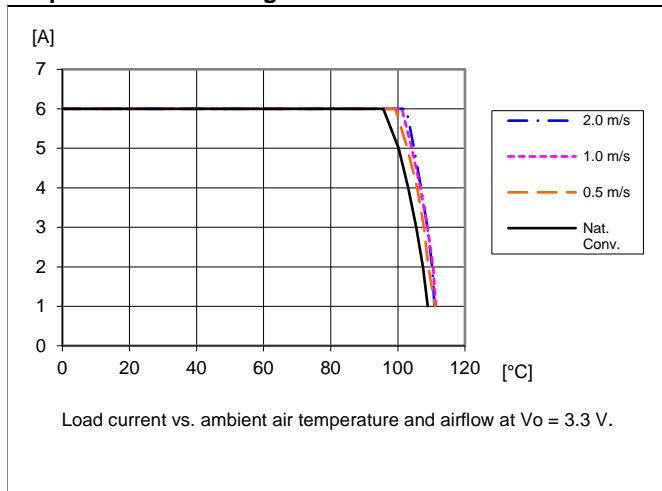

Output current derating

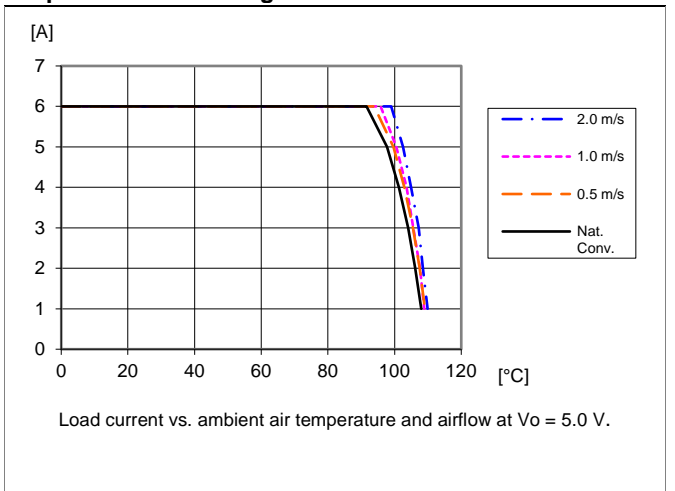

PMU 8000 Series PoL Regulators
 Input 4.5-17 V, Output up to 8 A / 44 W

 1/28701 - BMR668 Rev. D September 2020
 © Flex

1.0V, 8A / 8W Electrical Specification
PMU8418
 $T_{P1} = -40$ to $+105$ °C, $V_I = 4.5$ to 17 V, unless otherwise specified under Conditions.

 Typical values given at: $T_{P1} = +25$ °C, $V_I = 12$ V, max I_O , unless otherwise specified under Conditions.

 Additional $C_{IN} = 100$ μ F Electrolytic + 2×10 μ F Ceramic capacitors and $C_{OUT} = 4 \times 47$ μ F Ceramic capacitors.

Characteristics		Conditions	min	typ	max	Unit
V_I	Input voltage range		4.5	12	17	V
V_{loff}	Turn-off input voltage	Decreasing input voltage	3.7	3.9		V
V_{lon}	Turn-on input voltage	Increasing input voltage		4.1	4.3	V
C_I	Internal input capacitance			2		μ F
P_O	Output power		0		8.0	W
η	Efficiency	$V_I = 12$ V, 50 % of max I_O		88.2		%
		$V_I = 12$ V, max I_O		84.8		
P_d	Power Dissipation	$V_I = 12$ V, 50 % of max I_O		0.54		W
		$V_I = 12$ V, max I_O		1.43		W
P_{ii}	Input idling power	$V_I = 12$ V		0.17		W
P_{RC}	Input standby power	$V_I = 12$ V		20		mW
f_s	Switching frequency	10-100 % of max I_O		350		kHz
V_{oi}	Output voltage initial setting and accuracy	$V_I = 12$ V, max I_O		1.0		V
V_O	Output voltage tolerance band	10-100 % of max I_O		± 1.5		%
	Idling voltage	$V_I = 12$ V, $I_O = \text{min } I_O$		1.0		V
	Line regulation	$I_O = \text{max } I_O$		± 0.18		mV
	Load regulation	$V_I = 12$ V, 0-100 % of max I_O		± 1.81		mV
V_{tr}	Load transient voltage deviation	$V_I = 12$ V, Load step 25-75-25 % of max I_O , $di/dt = 2$ A/ μ s With Loop Optimization		± 55		mV
t_{tr}	Load transient recovery time	$C_{OUT} = 518$ μ F; $R_{LO} = 3$ k Ω		40		μ s
t_r	Ramp-up time (from 10–90 % of V_O)	$V_I = 12$ V, 100 % of max I_O		1.1		ms
t_s	Start-up time (from V_I connection to 90 % of V_O)			1.6		ms
t_f	V_I shut-down fall time. (from V_I off to 10 % of V_O)	$V_I = 12$ V	$I_O = \text{max } I_O$		9.7	ms
			$I_O = \text{min } I_O$		1.0	s
$t_{RC} t_{inh}$	RC start-up time	$V_I = 12$ V	$I_O = \text{max } I_O$		1.4	ms
	RC shut-down fall time (from RC off to 10 % of V_O)		$I_O = \text{max } I_O$		46.6	μ s
			$I_O = \text{min } I_O$		1.3	s
I_O	Output current		0		8	A
I_{lim}	Current limit threshold			11.7		A
I_{sc}	Short circuit current	RMS, 12 m Ω short		2.3		A
C_{in}	External input capacitance	Ceramic type		20		μ F
		Non-ceramic type, Note 2		100		
C_{out}	External output capacitance	Note 3	188		1500	μ F
V_{Oac}	Output ripple & noise $V_I = 12$ V	$I_O = \text{max } I_O$		9.66		mVp-p

Note 2. For Non-ceramic type of external input capacitor, a 100 μ F bulk capacitor is recommended for application with transient load requirement. An OS-CON capacitor is recommended when adding the bulk capacitor in low temperature.

Note 3. A minimum external output ceramic capacitance is required. In low output voltage, more capacitance might to be added considering capacitance derating. The maximum external output capacitor could only be ceramic type or combination of ceramic and a single non-ceramic type.

PMU 8000 Series PoL Regulators
 Input 4.5-17 V, Output up to 8 A / 44 W

1/28701 - BMR668 Rev. D September 2020
 © Flex

1.0V, 8A / 8W Typical Characteristics

PMU 8418

Efficiency

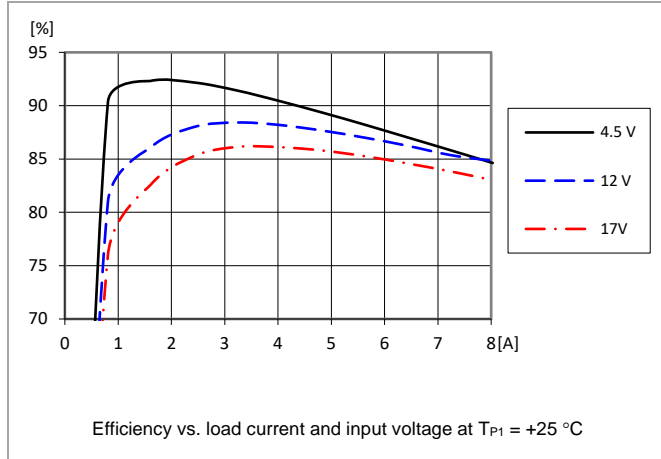

Power Dissipation

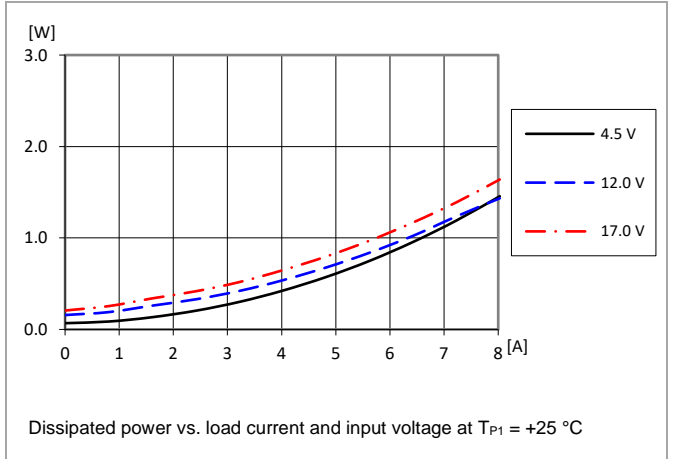

Output Ripple & Noise

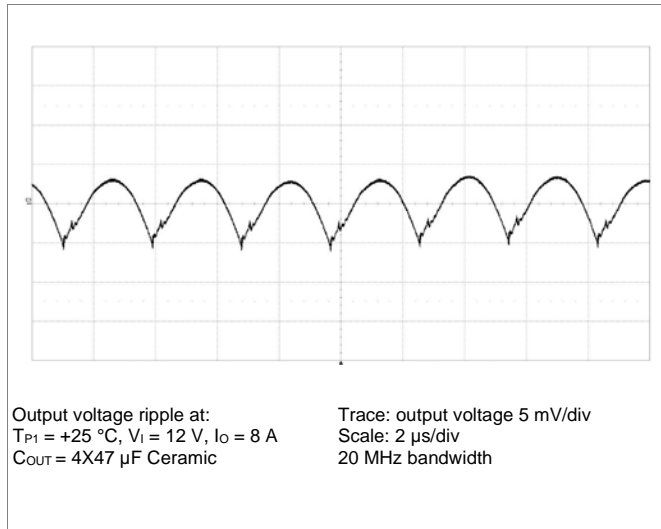

Transient Response

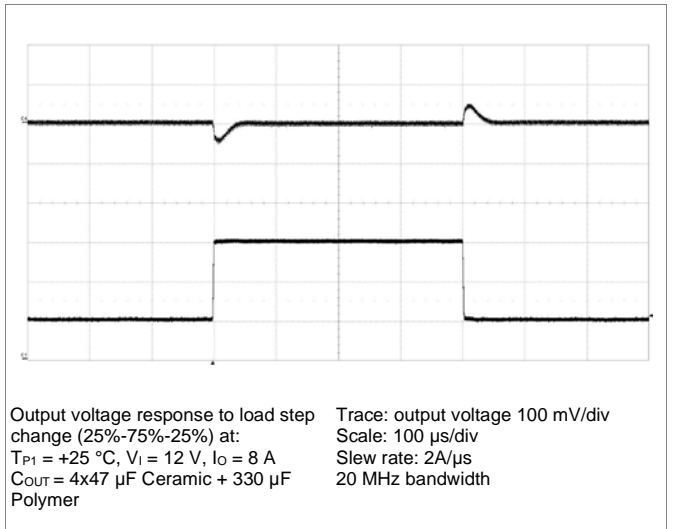

Start up by EN pin

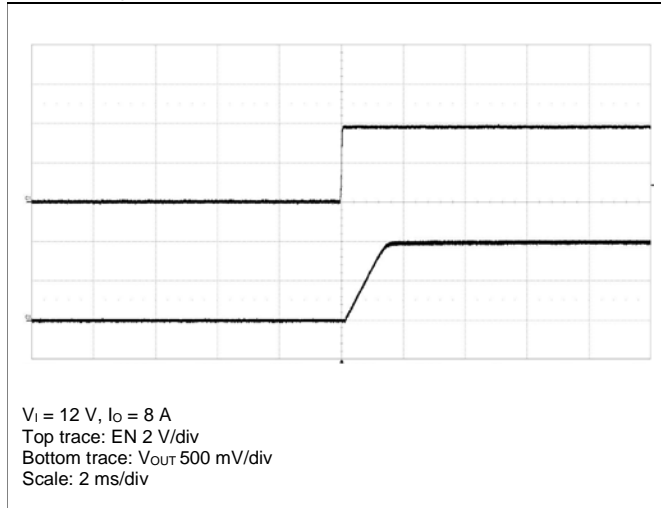

Shut down by EN pin

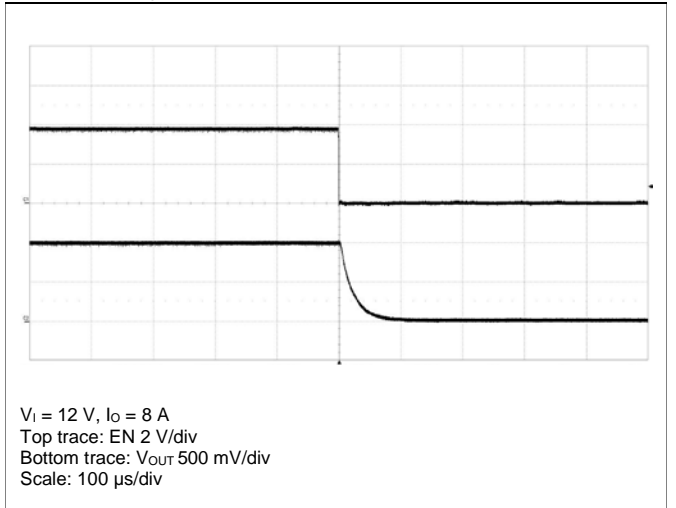

PMU 8000 Series PoL Regulators
 Input 4.5-17 V, Output up to 8 A / 44 W

 1/28701 - BMR668 Rev. D September 2020
 © Flex

3.3V, 8A / 26.4W Electrical Specification
PMU8418
 $T_{P1} = -40$ to $+105$ °C, $V_I = 4.5$ to 17 V, unless otherwise specified under Conditions.

 Typical values given at: $T_{P1} = +25$ °C, $V_I = 12$ V, max I_O , unless otherwise specified under Conditions.

 Additional $C_{IN} = 100$ μ F Electrolytic + 2×10 μ F Ceramic capacitors and $C_{OUT} = 4 \times 47$ μ F Ceramic capacitors.

Characteristics		Conditions	min	typ	max	Unit
V_I	Input voltage range		4.5	12	17	V
V_{loff}	Turn-off input voltage	Decreasing input voltage	3.7	3.9		V
V_{lon}	Turn-on input voltage	Increasing input voltage		4.1	4.3	V
C_I	Internal input capacitance			2		μ F
P_O	Output power		0		26.4	W
η	Efficiency	$V_I = 12$ V, 50 % of max I_O		93.0		%
		$V_I = 12$ V, max I_O		91.9		
P_d	Power Dissipation	$V_I = 12$ V, 50 % of max I_O		1.0		W
		$V_I = 12$ V, max I_O		2.3		W
P_{ii}	Input idling power	$V_I = 12$ V		0.4		W
P_{RC}	Input standby power	$V_I = 12$ V		20		mW
f_s	Switching frequency	0-100 % of max I_O		1.0		MHz
V_{Oi}	Output voltage initial setting and accuracy	$V_I = 12$ V, max I_O		3.31		V
V_O	Output voltage tolerance band	10-100 % of max I_O		± 1.5		%
	Idling voltage	$V_I = 12$ V, $I_O = \text{min } I_O$		3.31		V
	Line regulation	$I_O = \text{max } I_O$		± 0.6		mV
	Load regulation	$V_I = 12$ V, 0-100 % of max I_O		± 1.0		mV
V_{tr}	Load transient voltage deviation	$V_I = 12$ V, Load step 25-75-25 % of max I_O , $di/dt = 2$ A/ μ s With Loop Optimization		± 70		mV
t_{tr}	Load transient recovery time	$C_{OUT} = 518$ μ F; $R_{LO} = 11$ k		100		μ s
t_r	Ramp-up time (from 10-90 % of V_O)	$V_I = 12$ V, 100 % of max I_O		1.1		ms
t_s	Start-up time (from V_I connection to 90 % of V_O)			1.7		ms
t_f	V_I shut-down fall time. (from V_I off to 10 % of V_O)	$V_I = 12$ V	$I_O = \text{max } I_O$		6.9	ms
			$I_O = \text{min } I_O$		0.13	s
$t_{RC} t_{inh}$	RC start-up time		$V_I = 12$ V, max I_O		1.3	ms
	RC shut-down fall time (from RC off to 10 % of V_O)	$V_I = 12$ V	$I_O = \text{max } I_O$		0.18	ms
			$I_O = \text{min } I_O$		1.3	s
I_O	Output current		0		8	A
I_{lim}	Current limit threshold			11.7		A
I_{sc}	Short circuit current	RMS, 12 m Ω short		2.35		A
C_{in}	External input capacitance	Ceramic type		20		μ F
		Non-ceramic type, Note 2		100		
C_{out}	External output capacitance	Note 3		47	1500	μ F
V_{Oac}	Output ripple & noise $V_I = 12$ V	$I_O = \text{max } I_O$		3.96		mVp-p

 Note 2. For Non-ceramic type of external input capacitor, a 100 μ F bulk capacitor is recommended for application with transient load requirement. An OS-CON capacitor is recommended when adding the bulk capacitor in low temperature.

Note 3. A minimum external output ceramic capacitance is required. In low output voltage, more capacitance might to be added considering capacitance derating. The maximum external output capacitor could only be ceramic type or combination of ceramic and a single non-ceramic type.

PMU 8000 Series PoL Regulators
 Input 4.5-17 V, Output up to 8 A / 44 W

1/28701 - BMR668 Rev. D September 2020
 © Flex

3.3V, 8A / 26.4W Typical Characteristics

PMU 8418

Efficiency

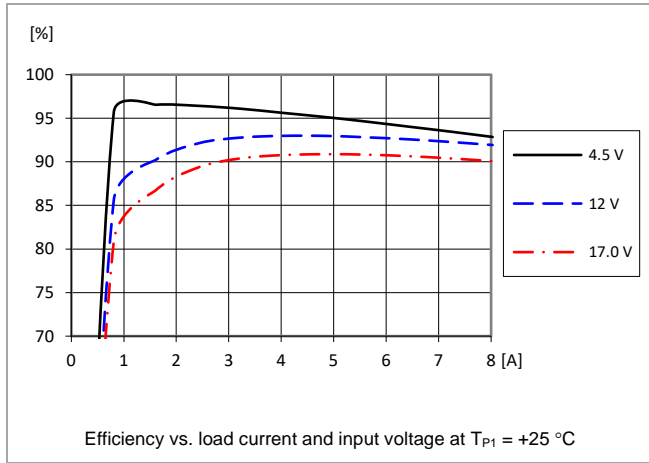

Power Dissipation

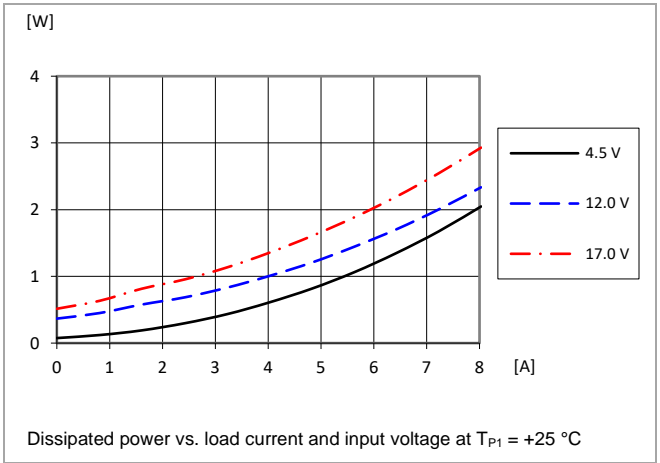

Output Ripple & Noise

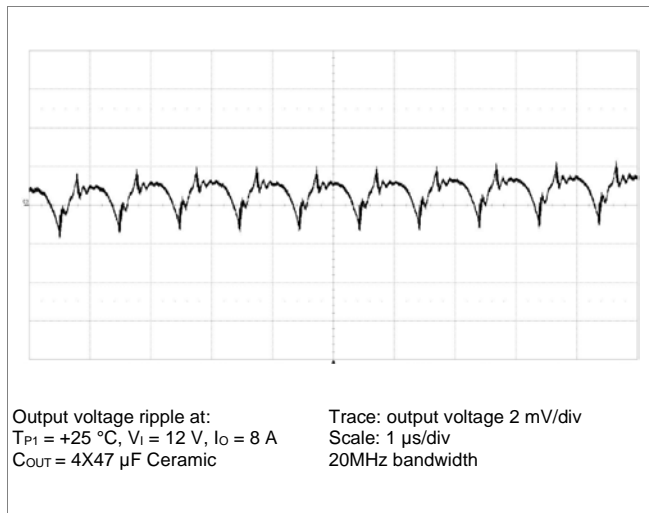

Transient Response

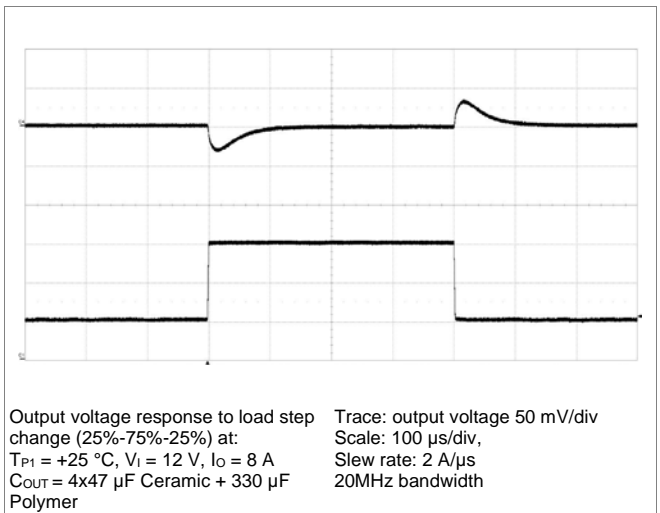

Start up by EN pin

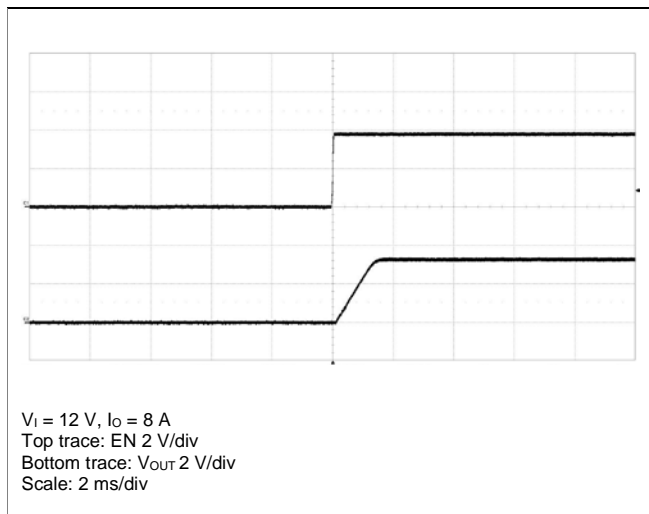

Shut down by EN pin

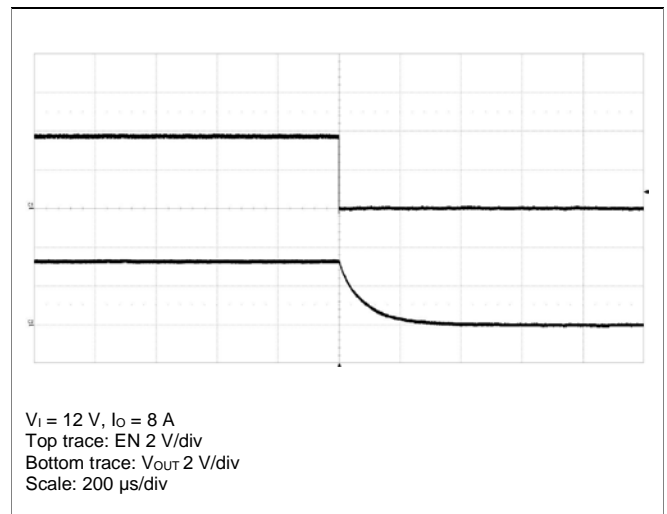

PMU 8000 Series PoL Regulators
 Input 4.5-17 V, Output up to 8 A / 44 W

1/28701 - BMR668 Rev. D September 2020
 © Flex

Typical Characteristics ($V_{IN} = 12V$)

PMU 8418

Efficiency

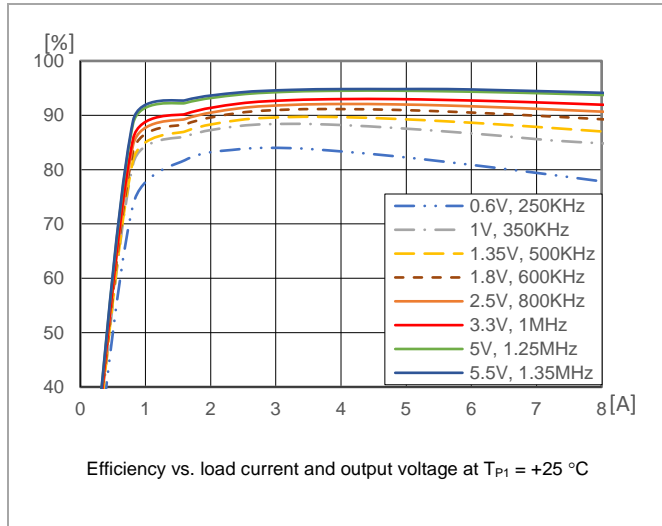

Power Dissipation

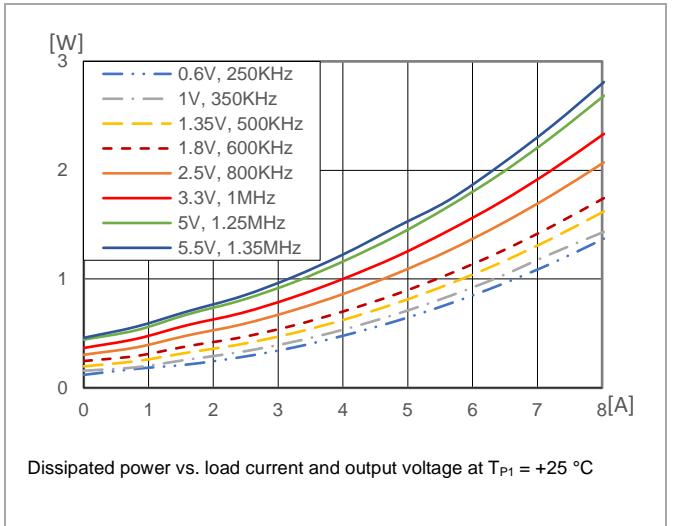

Output voltage ripple

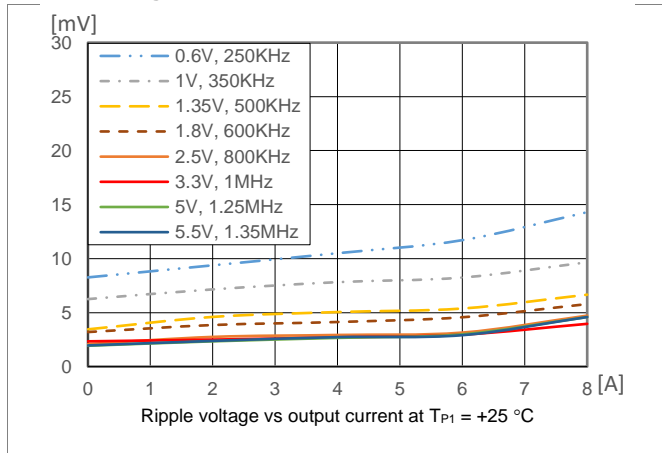

Output current derating

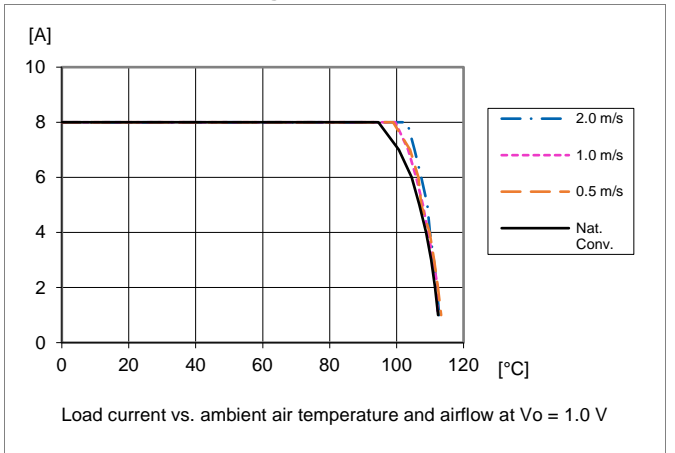

Output current derating

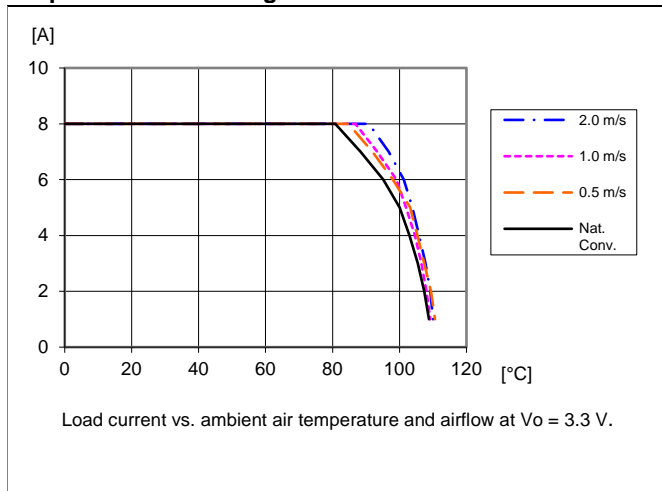

Output current derating

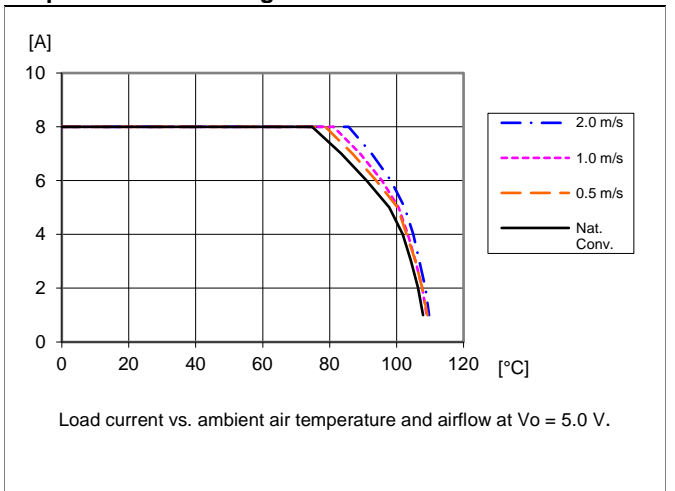

PMU 8000 Series PoL Regulators

Input 4.5-17 V, Output up to 8 A / 44 W

1/28701 - BMR668 Rev. D September 2020

© Flex

Output Ripple and Noise

Output ripple and noise are measured according to figure below.

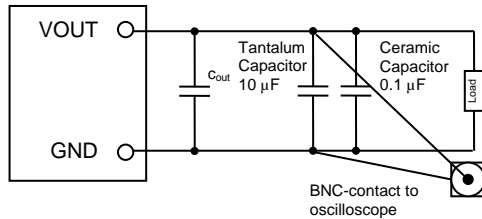

Output ripple and noise test set-up.

The module is designed for low ripple voltage at the module output and will meet the maximum output ripple specification with 0.1 μF ceramic and 10 μF tantalum at the output of the module.

The default loop compensation setting is designed to provide stability, accurate line and load regulation and good transient performance for a wide range of operating conditions (switching frequency, input voltage, output voltage, output capacitance). Inherent from the implementation and normal to the product there will be some low frequency ripple at the output, in addition to the fundamental switching frequency output ripple. This low frequency ripple is not related to instability of control loop. The total output ripple and noise is maintained at a low level.

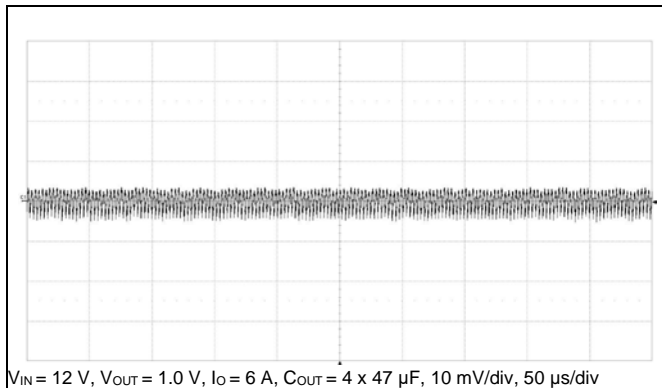

Example of low frequency ripple at the output.

Operating Information

Input Voltage

The input voltage range 4.5 to 17 V makes the product easy to use in wide applications.

- Telecom and wireless infrastructure
- Industrial automated test equipment
- Enterprise switching and storage applications
- High density distributed power systems

Turn-off Input Voltage

The product monitors the input voltage and will turn on and turn off at predetermined levels.

Remote Control (EN)

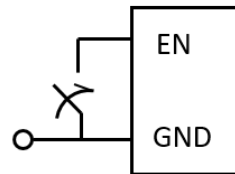

The products are equipped with a remote control function referenced to the input negative connection with positive logic. The remote control function allows the product to be turned on/off by an external device like a semiconductor or mechanical switch.

The product turns on when EN is high and turns off when EN is low. EN is also a dedicated pin that can be used to adjust the input undervoltage lockout. See [Undervoltage Lockout \(UVLO\)](#) section.

Input and Output Impedance

The impedance of both the input source and the load will interact with the impedance of the product. It is important that the input source has low characteristic impedance. If the input voltage source contains significant inductance, the addition of a capacitor with low ESR across the input of the product will ensure stable operation.

External Input Capacitor Selection

It is recommended to use a combination of ceramic capacitors and an electrolytic capacitor on the input side. The minimum required value of ceramic capacitance is 20 μF with recommended X5R or X7R features. Additional 100 μF non-ceramic capacitance is required for applications with large transient load requirements. At least 25V voltage rating capacitor is recommended to support maximum input voltage.

The required ceramic capacitors must be placed as close as possible to both V_{IN} pins to minimize the input voltage ripple.

To compensate the derating of ceramic capacitors, a voltage rating of twice the maximum input voltage is recommended. At worst case, when operating at 50% duty cycle and maximum load 8A, the combined ripple current rating of the input capacitors must be at least 4A(rms). See [Table 1](#) for a preferred list of capacitors by vendor.

PMU 8000 Series PoL Regulators
 Input 4.5-17 V, Output up to 8 A / 44 W

1/28701 - BMR668 Rev. D September 2020
 © Flex

External Output Capacitor Selection

The output capacitor must have a low ESR value to achieve low output ripple voltage. A low ESR value is critical also for a small output voltage deviation during load transients. See [Table 2](#) of recommended output capacitors.

External output capacitors must be placed as close as possible to both VOUT pins of the product. It is important to use low resistance and low inductance PCB layout and cabling for capacitance to be effective.

Polymer capacitors with capacitance and ESR are required in the range shown in [Table 3](#). Capacitors with lower ESR than the minimum listed ones can be used. However, if using a combination of ceramic and polymer type of output capacitance, only a single polymer capacitor can be used. In addition to output capacitor selection, improved transient response can also be achieved by adjusting the settings of the control loop of the product. See Loop Optimization (LO).

Output Voltage Adjust (FB)

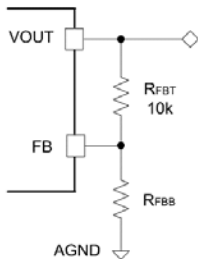

The output voltage can be set by means of external voltage divider, connected to the FB pin. The output voltage adjustment range is from 0.6V to 5.5V. The recommended RFBT is 10KΩ. The value for RFBB can be calculated by

$$R_{FBB} = \frac{6}{(V_{OUT} - 0.6)} \text{ (k}\Omega\text{)}$$

[Table 4](#) provides the selection of RFBB, the recommended switching frequency and minimum required output capacitance for different output voltage .

Switching Frequency (RT)

The fixed adjustable switching frequency range of the product is 200KHz to 1.6MHz. The switching frequency can be set by connecting a resistor RRT between the RT pin and AGND. RRT value is calculated by below fomula with a desired frequency or simply selected from [Table 4](#).

$$R_{RT} = 58650 \times F_{Sw} \text{ (kHz)}^{-1.028} \text{ (k}\Omega\text{)}$$

The switching frequency should be selected based on the output voltage setting of the device and the operating input voltage which are shown in [Table 5](#).

Loop Optimization (LO)

The product includes the LO feature which optimizes the transient response of the device while reducing the quantity of external output capacitors.

A loop optimization resistor RLO is required between the LO pin and AGND to properly set the response of the product based on the amount and type of output capacitors. Coefficient K is

introduced to calculate RLO. The value of COUT used in equation below is the total effective output capacitance, which takes into account the effects of applied voltage and temperature.

$$R_{LO} = \left[\left(\frac{K \times V_{OUT} \times C_{OUT(eff)} (\mu F)}{50} \right) - 2 \right] \text{ (k}\Omega\text{)}$$

The value of K is listed corresponding to different output voltage range and output capacitor types.

Only Ceramic Output Capacitors		Ceramic + Polymer Output Capacitors	
VOUT (V)	K	VOUT (V)	K
1- < 1.2	1	0.6- < 0.7	0.6
1.2- < 1.5	1.12	0.7- < 0.9	0.65
1.5- < 1.8	1.4	0.9- < 1	0.7
1.8- < 2	1.5	1- < 2.5	0.6
2- < 2.5	1.65	2.5- < 3.3	0.72
2.5- < 3.3	1.8	3.3- < 5	0.9
3.3- < 5.5	2.0	5.5	1.2

Transient Response

The device transient response is listed in [Table 6](#) for several common output voltages with different capacitor combinations. The calculated RLO value is included in the table along with typical voltage deviation. All data was taken at the recommended switching frequency for each output voltage.

Synchronization (CLK)

The product switching frequency can also be synchronized to an external clock from 200 kHz to 1.6 MHz.

To secure product working properly, the switching frequency value should be decided according to VIN, VOUT, and I0 conditions. See [Table 5](#) for the allowable operating ranges.

An internal Phase Locked Loop (PLL) has been implemented to allow synchronization and to switch from RT mode to CLK mode. To implement the synchronization feature, connect a square wave clock signal to the RT/CLK pin with a duty cycle from 20% to 80%. The clock signal amplitude must transit from voltage lower than 0.8 V to higher than 2 V. The start of the switching cycle is synchronized to the falling edge of the RT/CLK pin.

When external clock is not present, the device operates in RT mode and the switching frequency is set by the RT resistor. Select RRT to set the frequency close to the external synchronization one. When external clock is present, the CLK mode overrides the RT mode. First time the CLK pin is pulled above the RT/CLK high threshold (2 V), the device switches from the RT mode to the CLK mode and the RT/CLK pin becomes high impedance as the PLL starts to lock onto the frequency of the external clock. Once the external clock is removed, the internal clock frequency begins to drop. After 10 μs without receiving a clock pulse, the device returns to RT mode.

PMU 8000 Series PoL Regulators
Input 4.5-17 V, Output up to 8 A / 44 W

1/28701 - BMR668 Rev. D September 2020

© Flex

Table 1 Recommended Input Capacitors ⁽¹⁾

VENDOR	SERIES	PART NUMBER	CAPACITOR CHARACTERISTICS		
			VOLTAGE(V)	CAPACITANCE (μF) ⁽²⁾	ESR (mΩ) ⁽³⁾
TDK	X7R	C3225X7R1E106K250AC	25	10	2
Murata	X7R	GRM32DR71E106KA12L	25	10	2
Panasonic	ZA	EEHZA1H101P	50	100	28
Panasonic	FC	EEUFC1H101B	50	100	162

(1) Please consult capacitor suppliers regarding availability, material composition, RoHS and lead-free status, detail technical specification and manufacturing process requirements for any capacitors identified in this table.

(2) Specified capacitance values.

(3) Maximum ESR @ 100 kHz, 25 °C.

Table 2 Recommended Output Capacitors ⁽¹⁾

VENDOR	SERIES	PART NUMBER	CAPACITOR CHARACTERISTICS ⁽¹⁾		
			VOLTAGE(V)	CAPACITANCE (μF) ⁽²⁾	ESR (mΩ) ⁽³⁾
TDK	X7R	C3225X7R1C226K	16	22	2
Murata	X7R	GCJ32ER71C226K	16	22	2
TDK	X5R	C3225X5R1C226M	16	22	2
Murata	X5R	GRM32ER61C226K	16	22	2
Murata	X7R	GCM32ER70J476K	6.3	47	2
Murata	X7R	GRM32ER71A476K	10	47	2
Murata	X5R	GRM32ER61C476K	16	47	2
TDK	X5R	C3225X5R0J107M	6.3	100	2
Murata	X5R	GRM32ER60J107M	6.3	100	2
Murata	X5R	GRM32ER61A107M	10	100	2
Panasonic	POSCAP	4TPE220MF	4.0	220	15
Kemet	T520	T520D227M006ATE015	6.3	220	15
Panasonic	POSCAP	6TPE330MAA	6.3	330	10
Kemet	T520	T520D337M006ATE010	6.3	330	10
Panasonic	POSCAP	2R5TPE470M7	2.5	470	7
Kemet	T520	T520D477M2R5ATE007	2.5	470	7

(1) Please consult capacitor suppliers regarding availability, material composition, RoHS and lead-free status, detail technical specification and manufacturing process requirements for any capacitors identified in this table.

(2) Specified capacitance values.

(3) Maximum ESR @ 100 kHz, 25 °C.

PMU 8000 Series PoL Regulators
Input 4.5-17 V, Output up to 8 A / 44 W

1/28701 - BMR668 Rev. D September 2020

© Flex

Table 3 Low-ESR Polymer Capacitors

V _{OUT} RANGE	CAPACITANCE (μF)	ESR (mΩ)	
		min	max
0.6 V to < 3.3 V ⁽¹⁾	220	12	15
	270	9	12
	330 ⁽¹⁾	7	10
3.3 V to ≤ 5.5 V	150	15	25
	220	12	15
	270	9	12
	330	7	10

(1) Applications operating at input voltages > 15 V, output voltages < 3.3V, and temperatures below 0°C, the 330 μF capacitor is not recommended.

Table 4 Output Voltage Settings

V _{OUT} (V)	R _{FBB} (KΩ)	F _{SW} (KHz)	R _{RT} (KΩ)	Minimum Required C _{OUT} (μF) ⁽¹⁾⁽²⁾	
				CERAMIC	POLYMER ⁽³⁾
0.6	open	250	200	400	220
0.7	60.4	250	200	400	220
0.8	30.1	300	165	300	220
0.9	20.0	350	143	188	220
1.0	15.0	400	124	188	-
1.1	12.1	400	124	188	-
1.2	10.0	450	110	188	-
1.3	8.66	500	97.6	188	-
1.4	7.50	500	97.6	188	-
1.5	6.65	550	88.7	150	-
1.6	6.04	550	88.7	150	-
1.7	5.49	600	82.5	150	-
1.8	4.99	600	82.5	100	-
1.9	4.64	650	75.0	100	-
2.0	4.32	700	69.8	100	-
2.5	3.16	800	60.4	100	-
3.3	2.21	1000	48.7	47	-
5.0	1.37	1250	39	47	-
5.5	1.20	1350	36	47	-

(1) Additional capacitance above the minimum can be ceramic or polymer type.

(2) Load transients with > 2 A/μs slew rates or load steps exceeding 4 A may require additional capacitance, see [Loop Optimization \(LO\)](#).

(3) See [Table 3](#) for details on polymer capacitors.

PMU 8000 Series PoL Regulators
Input 4.5-17 V, Output up to 8 A / 44 W

1/28701 - BMR668 Rev. D September 2020

© Flex

Table 5 V_{OUT} Range vs Switching Frequency

SWITCHING FREQUENCY	V _{IN} =5V		V _{IN} =12V		V _{IN} =15V	
	V _{OUT} RANGE (V)		V _{OUT} RANGE (V)		V _{OUT} RANGE (V)	
	min	max	min	max	min	max
250 KHz	0.6	0.9	0.6	0.8	0.6	0.8
300 KHz	0.6	0.9	0.6	0.9	0.7	0.9
350 KHz	0.6	1.0	0.7	1.0	0.8	1.0
400 KHz	0.6	1.2	0.7	1.2	0.9	1.2
450 KHz	0.6	1.8	0.8	1.5	1.0	1.5
500 KHz	0.6	2.0	0.9	1.8	1.1	1.8
550 KHz	0.6	2.2	1.0	2.0	1.2	2.0
600 KHz	0.6	2.5	1.1	2.5	1.4	2.3
650 KHz	0.6	3.0	1.2	2.7	1.5	2.5
700 KHz	0.6	3.5	1.3	3.0	1.6	2.8
750 KHz	0.6	3.5	1.4	3.3	1.7	3.0
800 KHz	0.7	3.5	1.5	3.6	1.8	3.3
900 KHz	0.7	3.5	1.6	4.0	2.0	4.0
1.0 MHz	0.9	3.5	1.8	5.0	2.2	4.8
1.1 MHz	1.0	3.5	2.0	5.5	2.5	5.5
1.2 MHz	1.1	3.5	2.2	5.5	2.7	5.5
1.3 MHz	1.1	3.5	2.3	5.5	2.9	5.5
1.4 MHz	1.2	3.5	2.4	5.5	3.1	5.5
1.5 MHz	1.3	3.5	2.6	5.5	3.3	5.5
1.6 MHz	1.4	3.5	2.8	5.5	3.5	5.5

PMU 8000 Series PoL Regulators
Input 4.5-17 V, Output up to 8 A / 44 W

1/28701 - BMR668 Rev. D September 2020

© Flex

Table 6 Output Voltage Transient Response ⁽¹⁾

V _{OUT} (V)	C _{OUT1} Ceramic (μF)	C _{OUT2} Bulk (μF)	R _{Lo} (KΩ)	Voltage Deviation ⁽²⁾	
				1.5 A Load Step	3 A Load Step
0.6	4 x 47	330	1.62	11.90 mV	32.20 mV
	8 x 47	330	3.06	10.00 mV	26.80 mV
1.0	4 x 47	--	1.80	28.20 mV	74.00 mV
	4 x 47	330	4.16	12.70 mV	27.00 mV
	8 x 47	--	5.80	14.40 mV	36.20 mV
	8 x 47	330	6.56	9.70 mV	20.20 mV
1.35	4 x 47	--	3.85	27.00 mV	60.00 mV
	4 x 47	330	6.39	11.90 mV	25.80 mV
	8 x 47	--	9.90	14.40 mV	31.90 mV
	8 x 47	330	9.63	10.10 mV	20.20 mV
1.8	2 x 47	--	3.20	45.00 mV	86.00 mV
	2 x 47	330	7.09	16.90 mV	34.40 mV
	6 x 47	--	14.00	19.00 mV	39.00 mV
3.3	4 x 47	--	24.20	33.00 mV	68.00 mV
	2 x 47	330	23.34	16.20 mV	33.70 mV
	2 x 47	--	11.00	50.00 mV	98.00 mV
5.0	2 x 47	--	17.80	60.00 mV	117.00 mV
	2 x 47	330	49.40	16.50 mV	36.20 mV
	4 x 47	--	37.80	40.90 mV	82.00 mV

(1) V_{IN} = 12 V, C_{IN} = 2x10 μF Ceramic + 100 μF Electrolytic, T_A = 25 °C.

(2) Load step slew rate of 2 A/μs.

PMU 8000 Series PoL Regulators
 Input 4.5-17 V, Output up to 8 A / 44 W

1/28701 - BMR668 Rev. D September 2020
 © Flex

Transient Waveforms

V_{OUT} = 0.6V, C_{OUT} = 4 x 47 μF Ceramic + 330 μF Polymer

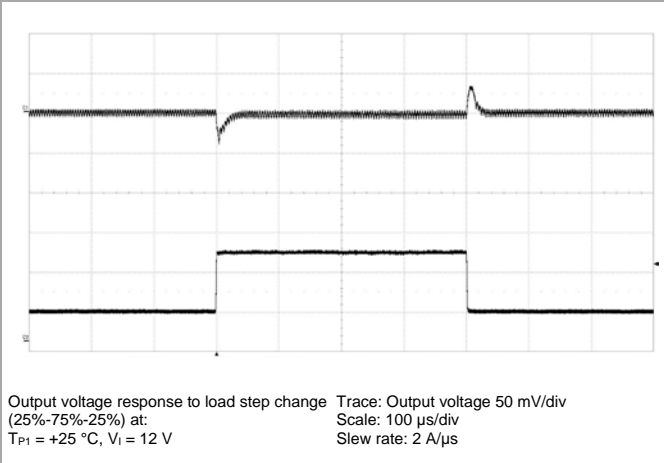

V_{OUT} = 0.6V, C_{OUT} = 8 x 47 μF Ceramic + 330 μF Polymer

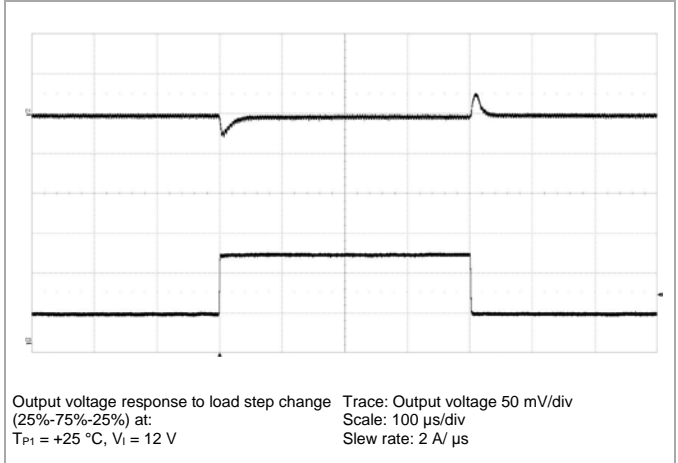

V_{OUT} = 1.0 V, C_{OUT} = 4 x 47 μF Ceramic + 330 μF Polymer

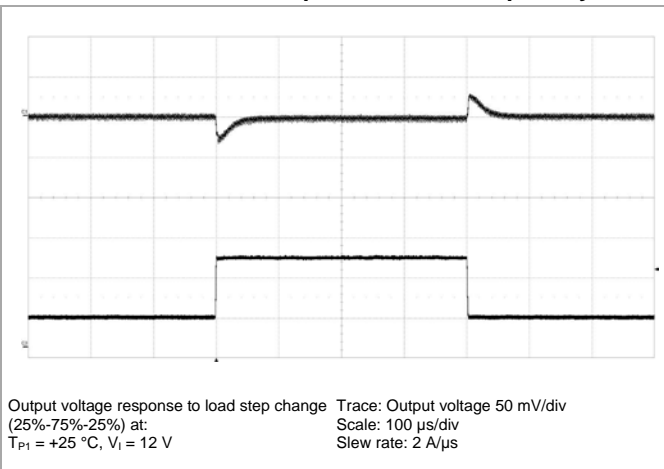

V_{OUT} = 1.0 V, C_{OUT} = 8 x 47 μF Ceramic + 330 μF Polymer

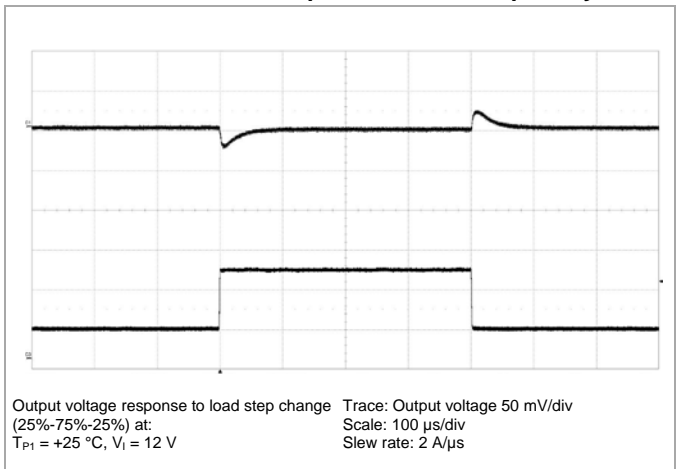

V_{OUT} = 1.35 V, C_{OUT} = 4 x 47 μF Ceramic + 330 μF Polymer

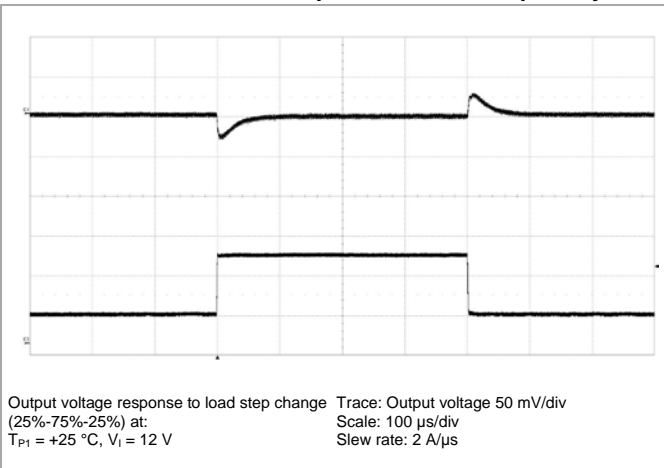

V_{OUT} = 1.35 V, C_{OUT} = 8 x 47 μF Ceramic + 330 μF Polymer

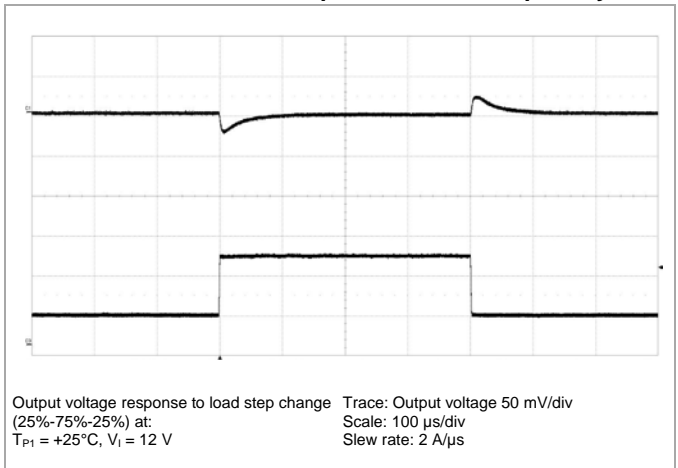

PMU 8000 Series PoL Regulators
 Input 4.5-17 V, Output up to 8 A / 44 W

1/28701 - BMR668 Rev. D September 2020
 © Flex

Undervoltage Lockout (UVLO)

The product implements internal UVLO circuitry on the VIN pin. The device is disabled when the VIN pin voltage falls below the internal VIN UVLO threshold. The internal VIN UVLO rising threshold is 4.1 V (typical) with a typical hysteresis of 200 mV.

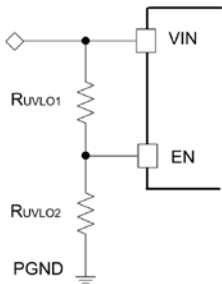

Applications may require a higher UVLO threshold to prevent early turn-on, for sequencing requirements, or to prevent input current draw at lower input voltages. An external voltage divider can be added to the EN pin to adjust the UVLO threshold higher. The external resistor divider can be configured as shown in figure.

Standard values for R_{UVLO1} and R_{UVLO2} to adjust the UVLO voltage higher are listed below.

V _{in} UVLO (V)	R _{UVLO1} (KΩ)	R _{UVLO2} (KΩ)	Hysteresis (mV)
4.5	68.1	24.3	385
5	68.1	21.5	400
6	68.1	16.9	430
7	68.1	14	465
8	68.1	12.1	500
9	68.1	10.5	530
10	68.1	9.31	565
11	68.1	8.45	600
12	68.1	7.50	640

Soft Start (SS)

The default soft-start time is approximately 1.25ms by leaving SS/TR pin open. To increase the soft-start time, additional capacitance between the SS pin and AGND should be added. Increasing soft-start time will reduce inrush current seen by the input source and reduce the current seen by the device when charging the output capacitors. To avoid the activation of current limit and ensure proper start-up, the SS capacitor may need to be increased when operating near the maximum output capacitance limit. To calculate the value

$$t_{ss} = \frac{0.6V \times (C_{ss} + 10nF)}{5\mu A}$$

Table below listed several typical capacitance and timing.

C _{ss} (nF)	SS Time (ms)
open	1.25
10	2.4
15	3
22	3.8
47	6.8

During soft start, the output voltage increases from its starting voltage and rises into regulation. The device is allowed to skip pulses as needed whenever the application conditions exceed the minimum on-time of the device. This behavior is a function of input voltage, output voltage, switching frequency, and load current. During the initial rise of the output voltage, adding an additional non-ceramic output capacitor in parallel with the required ceramic capacitance will improve the output voltage ramp-up.

Note that testing soft start performance with a pure resistive load is recommended. When using the electronic load, the output voltage noise can be exaggerated due to the control loop of the load.

Output Voltage Sequencing and Tracking (TR)

Many of the common power supply sequencing methods can be implemented using the SS/TR, EN, and PGOOD pins. The PGOOD pin of the first device is coupled to the EN pin of the second device which enables the second power supply once the primary supply reaches regulation.

Simultaneous power supply sequencing can be implemented by connecting the resistor network of R1 and R2 to the output of the power supply that needs to be tracked or to another voltage reference source.

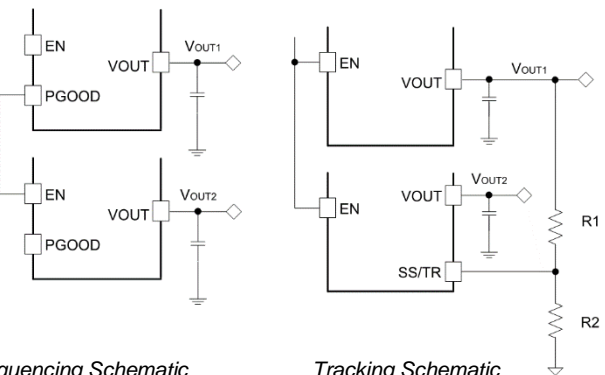

Sequencing Schematic

Tracking Schematic

R1 and R2 can be calculated by

$$R1 = \frac{V_{OUT1} \times 5}{0.6} (k\Omega)$$

$$R2 = \frac{0.6 \times R1}{V_{OUT1} - 0.6} (k\Omega)$$

PMU 8000 Series PoL Regulators
Input 4.5-17 V, Output up to 8 A / 44 W

1/28701 - BMR668 Rev. D September 2020

© Flex

Power Good (PGOOD)

The PGOOD pin is an open-drain output requiring an external pullup resistor to output a high signal. Once the output voltage is between 91% and 106% of the setpoint voltage and SS/TR is greater than 0.75 V, the PGOOD pin pulldown is released and the pin floats. A pullup resistor between the values of 10 kΩ and 100 kΩ is recommended to connect to a voltage source of 6.5 V or less. The PGOOD pin is pulled low when the output voltage is lower than 89% or greater than 108% of the setpoint voltage.

Safe Start-up into Pre-Biased Outputs

The device has been designed to prevent the low-side MOSFET from discharging a pre-biased output. During monotonic pre-biased startup, the low-side MOSFET is not allowed to sink current until the SS/TRK pin voltage is higher than the FB pin voltage and the high-side MOSFET begins to switch.

Over Current Protection (OCP)

The product is protected from over current conditions by cycle-by-cycle current limiting. During this period, the device will enter hiccup to reduce power dissipation. Once the fault is removed, the module automatically recovers and returns to normal operation.

Thermal Consideration

General

The product is designed to operate in different thermal environments and sufficient cooling must be provided to ensure reliable operation. Cooling is achieved mainly by conduction, from the pins to the host board, and convection, which is dependent on the airflow across the product. Increased airflow enhances the cooling of the product.

The Output Current Derating graph found in the Electrical Specification section for each model provides the available output current versus ambient air temperature and air velocity at specified VIN.

The product is tested on a 254 x 254 mm, 35 μm (1 oz) test board mounted vertically in a wind tunnel with a cross-section of 203 x 15 mm. The test board has 6 layers.

Note that the cooling via power pins does not only have to handle the power loss from the module. A low resistance between module and target device is of major importance to reduce additional power loss.

Definition of Product Operating Temperature

The temperature at positions P1 and P2 should not exceed the maximum temperatures in the table below. The number of measurement points may vary with different thermal design and topology. Temperatures above specified maximum measured at the specified positions are not allowed and may cause permanent damage.

Position	Description	Max Temperature
P1	M1, Power Inductor Reference Point	$T_{P1} = 125\text{ °C}$
P2	N1, Controller and Power Mosfet Hot Spot	$T_{P2} = 125\text{ °C}$

Note that the maximum value is the absolute maximum rating and the Electrical Specification is guaranteed up to Tref +105 °C.

Horizontal Direction

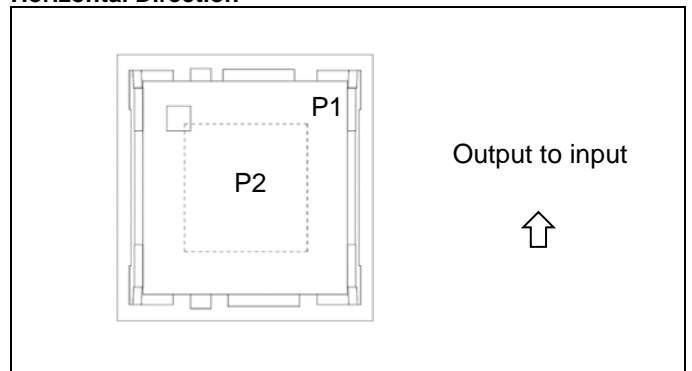

PMU 8000 Series PoL Regulators Input 4.5-17 V, Output up to 8 A / 44 W	1/28701 - BMR668 Rev. D September 2020
	© Flex

Definition of Reference Temperature TP1

The temperature at position P1 has been used as a reference temperature for the Electrical Specification data provided.

Over Temperature Protection (OTP)

The internal thermal shutdown circuitry forces the device to stop switching if the junction temperature exceeds 170 °C typically. The device reinitiates the power up sequence when the junction temperature drops below 155 °C typically.

Power Supply Considerations

The product is designed to operate from an input voltage supply range between 4.5 V and 17 V. This input supply must be well regulated and able to withstand maximum input current and maintain a stable voltage. The resistance of the input supply rail must be low enough that an input current transient does not cause a high enough drop at the product supply voltage that can cause a false UVLO fault triggering and system reset.

If the input supply is located more than a few inches from the product, additional bulk capacitance may be required in addition to the ceramic bypass capacitors.

PCB Layout Considerations

The radiated EMI performance of the product will depend on the PCB layout and ground layer design. If a ground layer is used, it should be connected to the output of the product and the equipment ground or chassis.

A ground layer will increase the stray capacitance in the PCB and improve the high frequency EMC performance.

Further layout recommendations are listed below.

- Resistors R_{FBB} , R_{RT} and C_{SS} should be placed as close as possible to their respective pins.
- Avoid current carrying planes under the small signal trace.
- The capacitors C_{IN} should be placed as close as possible to both VIN pins with low impedance connections.
- The capacitors C_{OUT} should also be placed close to both VOUT pins. Paralleling same number of output capacitors on each VOUT pin is recommended.
- Use large copper areas for power planes to minimize conduction loss and thermal stress.
- Keep AGND and PGND separate from one another. The connection is made internally.
- Use multiple via to connect the power planes to internal layers for improved thermal performance.
- The module size is 7.5 x 7.5 mm, for layout recommendation. See Mechanical Information.

PMU 8000 Series PoL Regulators
 Input 4.5-17 V, Output up to 8 A / 44 W

1/28701 - BMR668 Rev. D September 2020

© Flex

Mechanical Information - Surface Mount Version

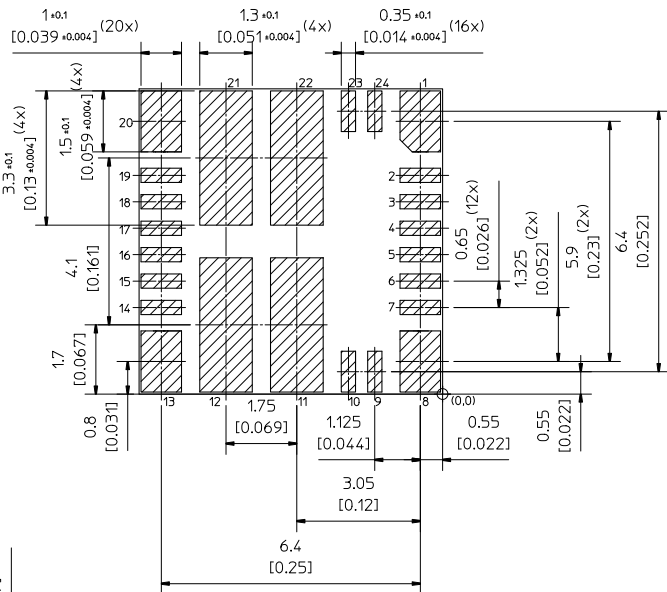
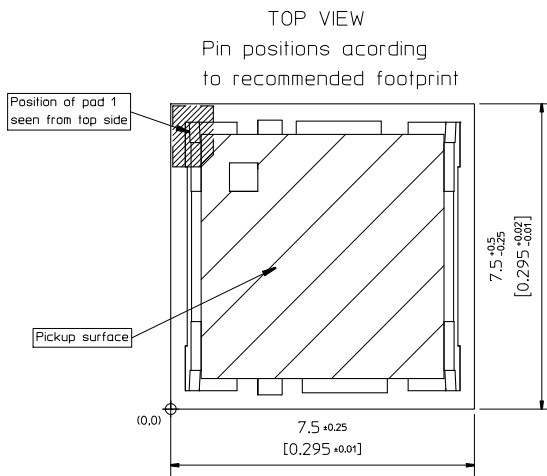
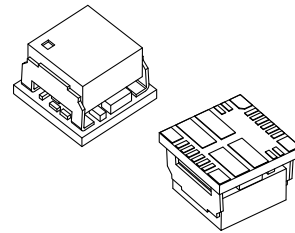
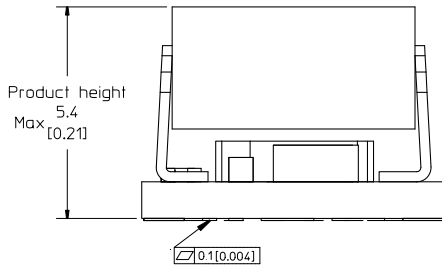

RECOMMENDED FOOTPRINT - TOP VIEW

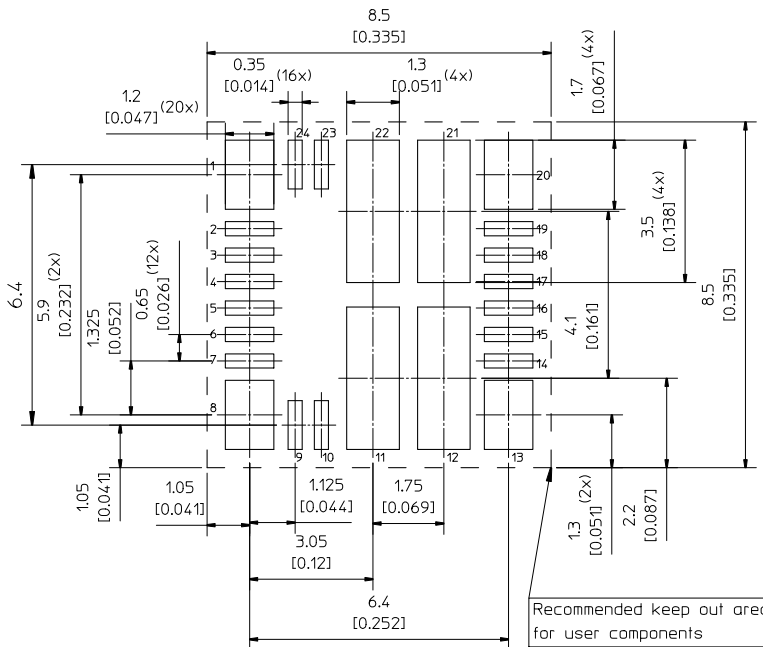

Weight: Typical 0.92 g
 All dimensions in mm [inch].
 Tolerances unless specified:
 x.x ±0.5 mm [0.02]
 x.xxx±0.25 mm [0.01]
 (not applied on footprint or typical values)



All component placements – whether shown as physical components or symbolical outline – are for reference only and are subject to change throughout the product's life cycle, unless explicitly described and dimensioned in this drawing.

PMU 8000 Series PoL Regulators
 Input 4.5-17 V, Output up to 8 A / 44 W

1/28701 - BMR668 Rev. D September 2020
 © Flex

Soldering Information - Surface Mounting

The surface mount product is intended for forced convection or vapor phase reflow soldering in SnPb or Pb-free processes.

The reflow profile should be optimised to avoid excessive heating of the product. It is recommended to have a sufficiently extended preheat time to ensure an even temperature across the host PCB and it is also recommended to minimize the time in reflow.

A no-clean flux is recommended to avoid entrapment of cleaning fluids in cavities inside the product or between the product and the host board, since cleaning residues may affect long time reliability and isolation voltage.

General reflow process specifications		SnPb eutectic	Pb-free
Average ramp-up ($T_{PRODUCT}$)		3°C/s max	3°C/s max
Typical solder melting (liquidus) temperature	T_L	183°C	221°C
Minimum reflow time above T_L		30 s	30 s
Minimum pin temperature	T_{PIN}	210°C	235°C
Peak product temperature	$T_{PRODUCT}$	225°C	260°C
Average ramp-down ($T_{PRODUCT}$)		6°C/s max	6°C/s max
Maximum time 25°C to peak		6 minutes	8 minutes

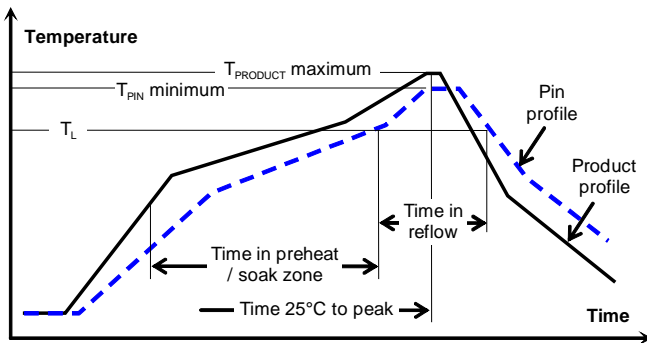

Minimum Pin Temperature Recommendations

Pin number 11 or 12 are chosen as reference location for the minimum pin temperature recommendation since these will likely be the coolest solder joint during the reflow process.

SnPb solder processes

For SnPb solder processes, a pin temperature (T_{PIN}) in excess of the solder melting temperature, (T_L , 183°C for Sn63Pb37) for more than 30 seconds and a peak temperature of 210°C is recommended to ensure a reliable solder joint.

For dry packed products only: depending on the type of solder paste and flux system used on the host board, up to a recommended maximum temperature of 245°C could be used, if the products are kept in a controlled environment (dry pack handling and storage) prior to assembly.

Lead-free (Pb-free) solder processes

For Pb-free solder processes, a pin temperature (T_{PIN}) in excess of the solder melting temperature (T_L , 217 to 221°C for SnAgCu solder alloys) for more than 30 seconds and a peak temperature of 235°C on all solder joints is recommended to ensure a reliable solder joint.

Maximum Product Temperature Requirements

Top of the product PCB near pin 4 or 5 is chosen as reference locations for the maximum (peak) allowed product temperature ($T_{PRODUCT}$) since these will likely be the warmest part of the product during the reflow process.

SnPb solder processes

For SnPb solder processes, the product is qualified for MSL 1 according to IPC/JEDEC standard J-STD-020C.

During reflow $T_{PRODUCT}$ must not exceed 225 °C at any time.

Pb-free solder processes

For Pb-free solder processes, the product is qualified for MSL 3 according to IPC/JEDEC standard J-STD-020C.

During reflow $T_{PRODUCT}$ must not exceed 260 °C at any time.

Dry Pack Information

Surface mounted versions of the products are delivered in standard moisture barrier bags according to IPC/JEDEC standard J-STD-033 (Handling, packing, shipping and use of moisture/reflow sensitivity surface mount devices).

Using products in high temperature Pb-free soldering processes requires dry pack storage and handling. In case the products have been stored in an uncontrolled environment and no longer can be considered dry, the modules must be baked according to J-STD-033.

Thermocoupler Attachment

Top of PWB near pin 4 or 5 for measurement of maximum product temperature, $T_{PRODUCT}$

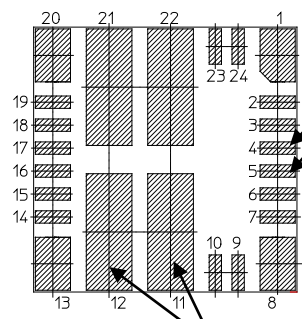

Pin 11 or 12 for measurement of minimum Pin (solder joint) temperature T_{PIN}

PMU 8000 Series PoL Regulators
 Input 4.5-17 V, Output up to 8 A / 44 W

1/28701 - BMR668 Rev. D September 2020
 © Flex

Surface Mount Assembly

The product require particular care during assembly. Automatic pick and place equipment should be used to mount the product on the host board. The use of a vision system, utilizing the fiducials on the bottom side of the product, will ensure adequate accuracy. Manual mounting is not recommended.

This module can be used for assembly on the bottom side of a customer board.

Delivery Package Information

The products are delivered in antistatic carrier tape (EIA 481 standard).

Carrier Tape Specifications – 13 inch Reel	
Material	PS, antistatic
Surface resistance	< 10 ⁷ Ohm/square
Bakeability	The tape is not bakable
Tape width, W	24 mm [0.94 inch]
Pocket pitch, P₁	16 mm [0.63 inch]
Pocket depth, K₀	5.9 mm [0.232 inch]
Reel diameter	330 mm [13 inch]
Reel capacity	600 products /reel
Reel weight	800 g/full reel

Carrier Tape Specifications – 7 inch Reel	
Material	PS, antistatic
Surface resistance	< 10 ⁷ Ohm/square
Bakeability	The tape is not bakable
Tape width, W	24 mm [0.94 inch]
Pocket pitch, P₁	16 mm [0.63 inch]
Pocket depth, K₀	5.9 mm [0.232 inch]
Reel diameter	178 mm [7 inch]
Reel capacity	150 products /reel
Reel weight	220 g/full reel

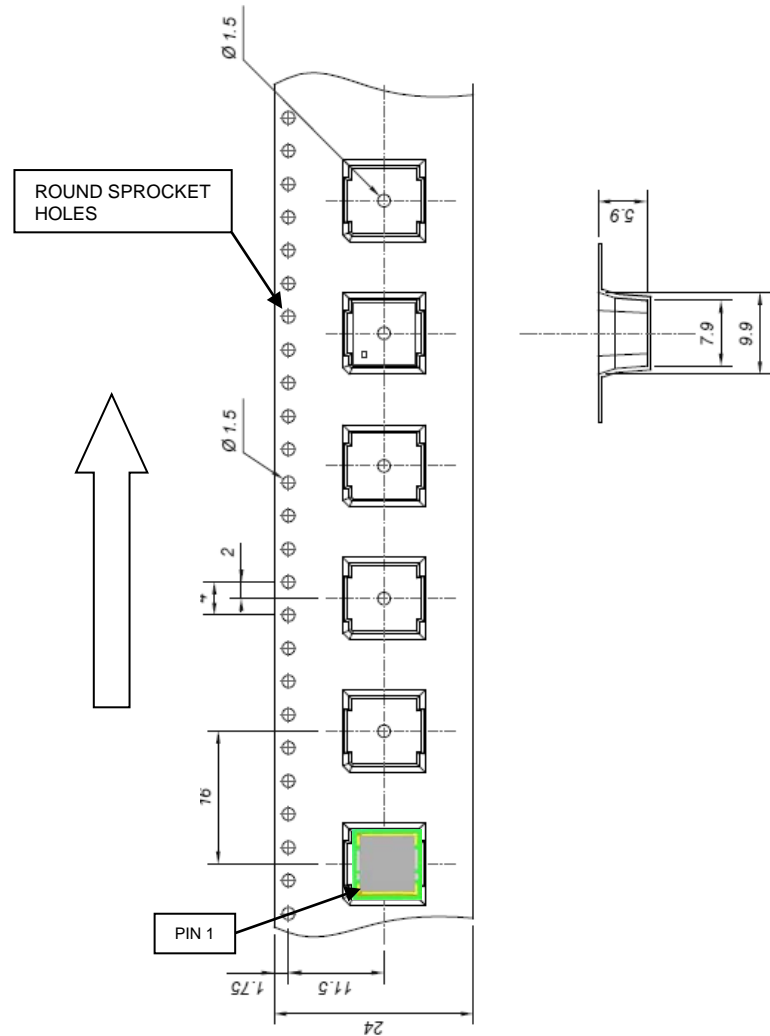

PMU 8000 Series PoL Regulators
Input 4.5-17 V, Output up to 8 A / 44 W

1/28701 - BMR668 Rev. D September 2020

© Flex

Product Qualification Specification

Characteristics			
External visual inspection	IPC-A-610		
Change of temperature (Temperature cycling)	IEC 60068-2-14 Na	Temperature range Number of cycles Dwell/transfer time	-40 to 125°C 700 15 min/0-1 min
Cold (in operation)	IEC 60068-2-1 Ad	Temperature T _A Duration	-45°C 72 h
Damp heat	IEC 60068-2-67 Cy	Temperature Humidity Duration	85°C 85 % RH 1000 hours
Dry heat	IEC 60068-2-2 Bd	Temperature Duration	125°C 1000 h
Electrostatic discharge susceptibility	IEC 61340-3-1, JESD 22-A114 IEC 61340-3-2, JESD 22-A115	Human body model (HBM) Machine Model (MM)	Class 2, 2000 V Class 3, 200 V
Immersion in cleaning solvents	IEC 60068-2-45 XA, method 2	Water Glycol ether Isopropyl alcohol	55°C 35°C 35°C
Mechanical shock	IEC 60068-2-27 Ea	Peak acceleration Duration	100 g 6 ms
Moisture reflow sensitivity	J-STD-020C	Level 1 (SnPb-eutectic) Level 3 (Pb Free)	225°C 260°C
Operational life test	MIL-STD-202G, method 108A	Duration	1000 h
Robustness of terminations	IEC 60068-2-21 Test Ua1 IEC 60068-2-21 Test Ue1	Through hole mount products Surface mount products	All leads All leads
Solderability	IEC 60068-2-58 test Td	Preconditioning Temperature, SnPb Eutectic Temperature, Pb-free	150°C dry bake 16 h 215°C 235°C
Vibration, broad band random	IEC 60068-2-64 Fh, method 1	Frequency Spectral density Duration	10 to 500 Hz 0.07 g ² /Hz 10 min in each 3 perpendicular directions