

Dimension:
Unit=mm

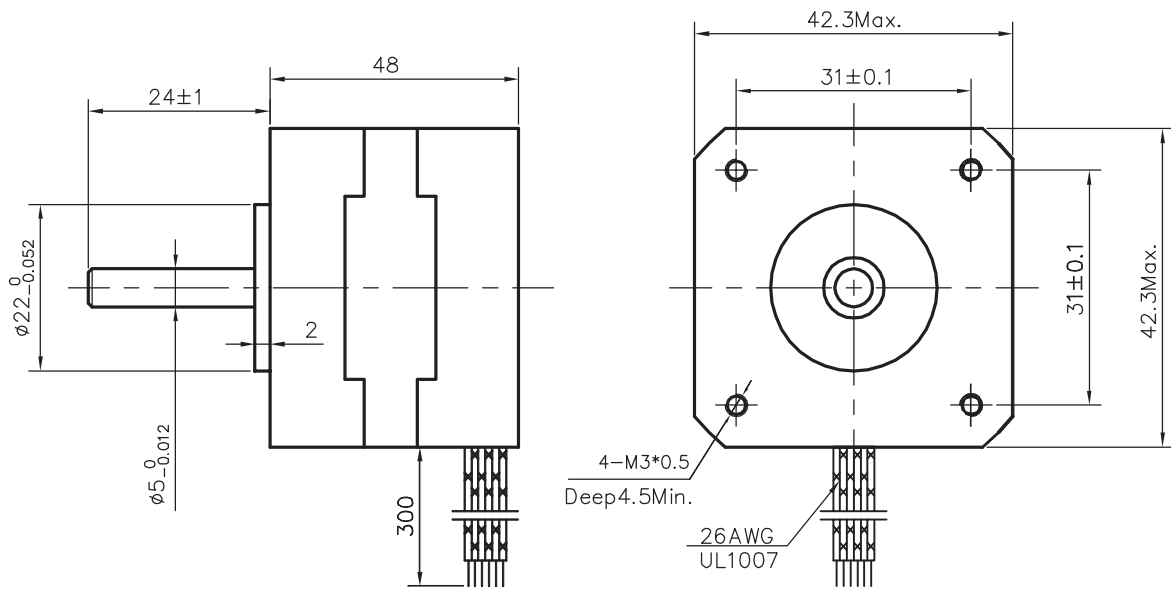

Specifications:

Phase	2		Comment
Step Angle	0.9	deg.	
Voltage	3.0	V	
Current	1.68	A	
Resistance	1.8	Ω	
Inductance	5.0	mH	
Holding Torque	4.4	kg.cm	
Insulation Class	B		
Mass	0.34	kg	

Wiring Diagram:

