

Rev.	Modify	Date	Firma	Approved

Rev.	Modify	Date	Firma	Approved

Rev.	Modify	Date	Signed	Approved
01	-	2017.09.04	SUGLIANI CIMMINO	

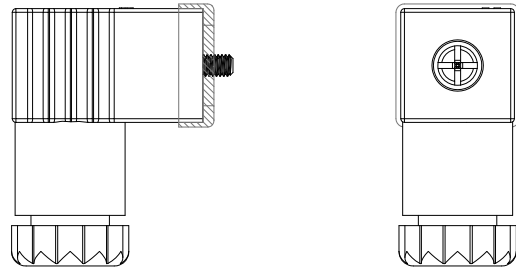
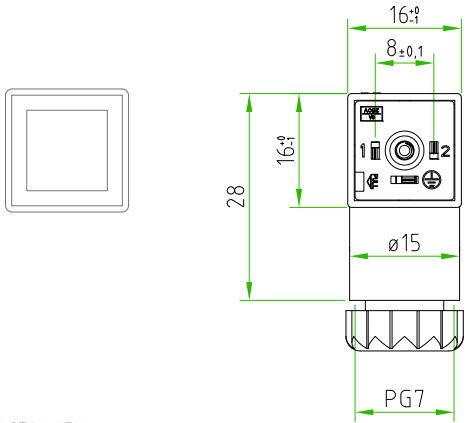
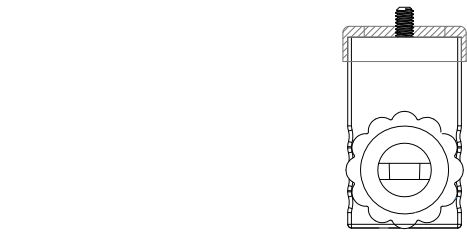
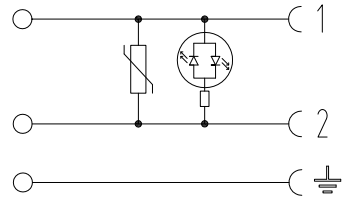

CONTACTS WITH SOLDER ZONE

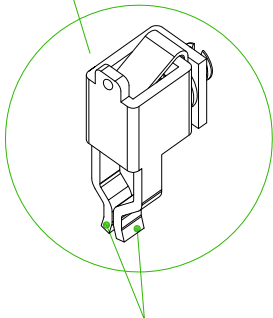

SPRING CONTACTS

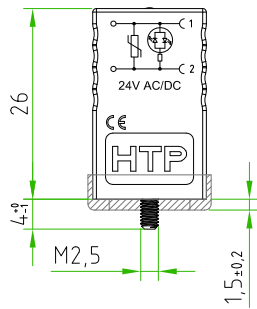

CONNECTOR FEATURES	PRODUCT TYPE	SQUARE MICRO CONNECTOR EN175301-803 FORM C FIELD ATTACHABLE.
	HOUSING MATERIAL/COLOUR	PA66 /TRASPARENT
	PRESS-CABLE MATERIAL/COLOUR	PA66 /BLACK
	INTERNAL CORE MATERIAL/COLOUR	PA66 /BLACK
	HEIGHT HOUSING	26mm
	CONTACTS SPACING	8mm
	CONTACTS TYPE	SCREW CONTACTS(with protection plate)
	NUMBER OF POLES	2POLES+EARTH
	EARTH POSITIONING	H.6 (TURNABLE)
	CABLE EXIT	PG7
	SUITABLE CABLE	REV.01 FROM ø3,5mm TO ø6mm
	MAX.CONDUCTOR SIZE	0,75mm ²
	PROTECTION CLASS	IP67
CIRCUIT TYPE	BIPOLAR RED LED+VARISTOR	
RATED VOLTAGE	24V AC/DC	
CONNECTOR TEMPERATURE RANGE	from -40°C to +90°C	
GASKET TYPE	PROFILED NBR	
FIXING SCREW	M2,5X0,5 L=28mm	
CONNECTOR WITH H.T.P. LOGO		

CUSTOMER APPROVAL	
SIGNATURE	DATE
PLEASE SIGN AND RETURN	

A4

Designer	SUGLIANI R.	Date	2017-07-20	Tolerance	±0,3	Units:	mm	Series	EN175301-803 (form C)	Drawing n. 1/1
Approved	CIMMINO L.	Date	2017-07-20	Scale	1:1	Size:	A4	Customer code:		

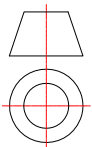

DESCRIPTION

SQUARE MICRO CONNECTOR EN175301-803 (form C),FIELD ATTACHABLE,2P.+PE, WITH BIPOLAR RED LED+VARISTOR, 24V AC/DC, TRASPARENT HOUSING, PG7. CONNECTOR WITH H.T.P. LOGO.

H.T.P.PART NUMBER

P1TZ2VL1